

# MA4SW410

## HMIC™ Silicon SP4T PIN Diode Switch RoHS Compliant

V6

### Features

- ◆ Broad Bandwidth
- ◆ Specified from 50 MHz to 20 GHz
- ◆ Usable from 50 MHz to 26.5 GHz
- ◆ Lower Insertion Loss and Higher Isolation than Comparable pHEMT or Discrete Component Designs
- ◆ Rugged Fully Monolithic
- ◆ Glass Encapsulated Chip with Polymer Protective Coating
- ◆ Up to +30dBm C.W. Power Handling @ +25°C
- ◆ 50 nS Switching Speed

### Description

The MA4SW410 is a SP4T, series-shunt, broadband, PIN diode switch made with M/A-COM's Tech's patented HMIC™ (Heterolithic Microwave Integrated Circuit) process. This process allows the silicon pedestals which form the series - shunt diodes and vias to be embedded into low loss, low dispersion glass. By also incorporating small spacing between circuit elements, the result is an HMIC chip with low insertion loss and high isolation at frequencies up to 26.5GHz. It is designed to be used as a moderate power, high performance switch and provide superior performance when compared to similar designs that use discrete components.

The top side of the chip is protected by a polymer coating for manual or automatic handling and large gold bond pads help facilitate connection of low inductance ribbons. The gold metallization on the backside of the chip allows for attachment via 80/20, gold/tin solder or conductive silver epoxy.

### Applications

The MA4SW410 is a high performance switch suitable for use in multi-band ECM, radar, and instrumentation control circuits where high isolation to insertion loss ratios are required. With a standard ±5V, TTL controlled, PIN diode driver, 50nS switching speeds are achievable.

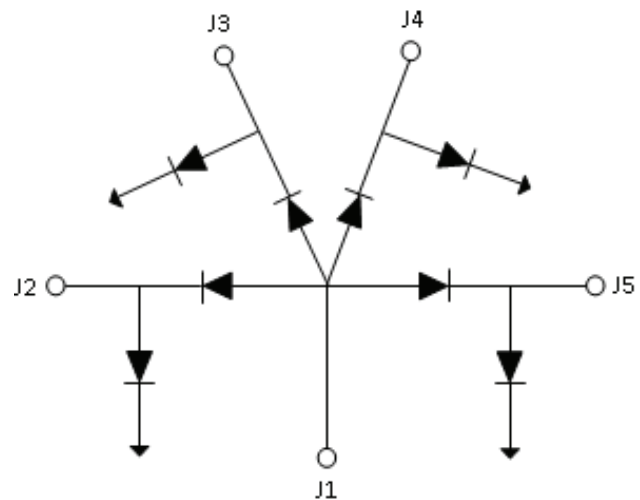
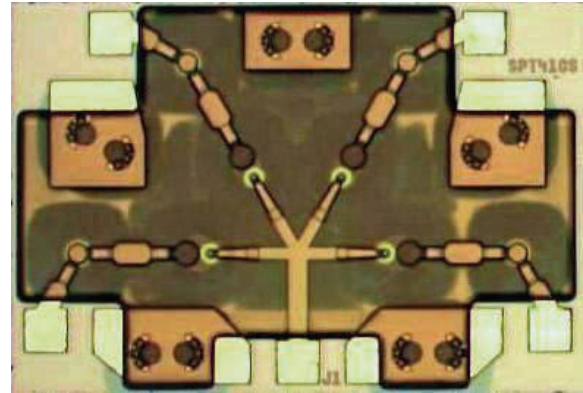

### Absolute Maximum Ratings T<sub>AMB</sub> = +25°C ( Unless Otherwise Specified )

Parameter	Value
Operating Temperature	-65°C to +125°C
Storage Temperature	-65°C to +150°C
RF C.W. Incident Power	+30dBm
Forward Bias Current per Port	± 50mA
Reverse Applied Voltage	-25 Volts

**Max. operating conditions for a combination of RF power, D.C. bias and temperature:  
+30dBm CW @ 15mA (per diode) @+85°C**

**ADVANCED:** Data Sheets contain information regarding a product M/A-COM is considering for development. Performance is based on target specifications, simulated results, and/or prototype measurements. Commitment to develop is not guaranteed.

**PRELIMINARY:** Data Sheets contain information regarding a product M/A-COM has under development. Performance is based on engineering tests. Specifications are typical. Mechanical outline has been fixed. Engineering samples and/or test data may be available. Commitment to produce in volume is not guaranteed.

- **North America** Tel: 800.366.2266 / Fax: 978.366.2266
- **Europe** Tel: 44.1908.574.200 / Fax: 44.1908.574.300
- **Asia/Pacific** Tel: 81.44.844.8296 / Fax: 81.44.844.8298

Visit [www.macom.com](http://www.macom.com) for additional data sheets and product information.

M/A-COM Inc. and its affiliates reserve the right to make changes to the product(s) or information contained herein without notice.

# MA4SW410

**HMIC™ Silicon SP4T PIN Diode Switch**  
**RoHS Compliant**

V6

## Electrical Specifications @ T<sub>AMB</sub> = +25°C, ± 20mA Bias Current (On-Wafer Measurements)

Parameter	Frequency	Minimum	Nominal	Maximum	Units
Insertion Loss	20 GHz		0.9	1.3	dB
Isolation	20 GHz	28	34		dB
Input Return Loss	20 GHz		15		dB
Output Return Loss	20 GHz		15		dB
Switching Speed <sup>1</sup>	10 GHz		50		nS

**Note:**

1. Typical switching speed is measured from 10% to 90% of detected RF voltage driven by a TTL compatible driver. Driver output parallel RC network uses a capacitor between 390pF – 560pF and a resistor between 150Ω – 220Ω to achieve 50nS rise and fall times.

## Typical Driver Connections

Control Level ( DC Current ) at Port				Condition of RF Output	Condition of RF Output	Condition of RF Output	Condition of RF Output
J2	J3	J4	J5	J1 - J2	J1 - J3	J1 - J4	J1 - J5
-20mA	+20mA	+20mA	+20mA	<b>Low Loss</b>	Isolation	Isolation	Isolation
+20mA	-20mA	+20mA	+20mA	Isolation	<b>Low Loss</b>	Isolation	Isolation
+20mA	+20mA	-20mA	+20mA	Isolation	Isolation	<b>Low Loss</b>	Isolation
+20mA	+20mA	+20mA	-20mA	Isolation	Isolation	Isolation	<b>Low Loss</b>

**Compatible M/A-COM Tech Driver**

[MADR-009190-000100](#)

**ADVANCED:** Data Sheets contain information regarding a product M/A-COM is considering for development. Performance is based on target specifications, simulated results, and/or prototype measurements. Commitment to develop is not guaranteed.

**PRELIMINARY:** Data Sheets contain information regarding a product M/A-COM has under development. Performance is based on engineering tests. Specifications are typical. Mechanical outline has been fixed. Engineering samples and/or test data may be available. Commitment to produce in volume is not guaranteed.

- **North America** Tel: 800.366.2266 / Fax: 978.366.2266
- **Europe** Tel: 44.1908.574.200 / Fax: 44.1908.574.300
- **Asia/Pacific** Tel: 81.44.844.8296 / Fax: 81.44.844.8298

Visit [www.macom.com](http://www.macom.com) for additional data sheets and product information.

M/A-COM Inc. and its affiliates reserve the right to make changes to the product(s) or information contained herein without notice.

# MA4SW410

HMIC™ Silicon SP4T PIN Diode Switch  
RoHS Compliant

V6

## Operation of the MA4SW410 PIN Switch

The simultaneous application of a negative DC current to the low loss port and positive DC current to the isolated ports as shown below in Fig.1 is required for proper operation of the switch. The backside area of the die is the RF and DC ground return and the DC return is through the common Port J1. A constant current source should be used to supply the DC control currents. The control voltages at these points will not exceed  $\pm 1.5$  volts for supply currents up to  $\pm 20$ mA. In the low loss state, the series diode must be forward biased and the shunt diode reverse biased. On all isolated ports, the shunt diode is forward biased and the series diode is reverse biased. A typical bias network design that will produce  $>30$ dB RF to DC isolation is shown below in Figure 1 .

The optimum insertion loss, P1dB, IP3, and switching speed are attained by using a voltage pull-up resistor in the DC return path, J1. A minimum value of  $|-2V|$  is recommended using a standard,  $\pm 5V$  TTL controlled PIN driver such as M/A-COM Tech's [MADR-009190-000100](http://www.macom.com/products/MADR-009190-000100).

## Typical 2 – 18 GHz Bias Network

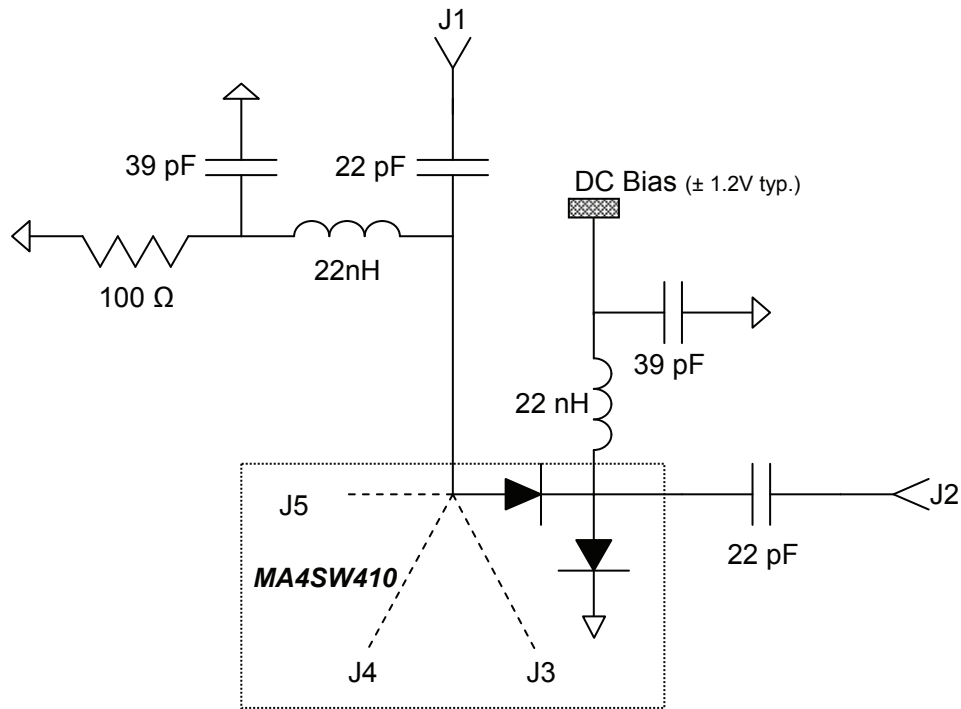

Fig. 1

**ADVANCED:** Data Sheets contain information regarding a product M/A-COM is considering for development. Performance is based on target specifications, simulated results, and/or prototype measurements. Commitment to develop is not guaranteed.

**PRELIMINARY:** Data Sheets contain information regarding a product M/A-COM has under development. Performance is based on engineering tests. Specifications are typical. Mechanical outline has been fixed. Engineering samples and/or test data may be available. Commitment to produce in volume is not guaranteed.

- **North America** Tel: 800.366.2266 / Fax: 978.366.2266
- **Europe** Tel: 44.1908.574.200 / Fax: 44.1908.574.300
- **Asia/Pacific** Tel: 81.44.844.8296 / Fax: 81.44.844.8298

Visit [www.macom.com](http://www.macom.com) for additional data sheets and product information.

M/A-COM Inc. and its affiliates reserve the right to make changes to the product(s) or information contained herein without notice.

# MA4SW410

HMIC™ Silicon SP4T PIN Diode Switch  
RoHS Compliant

V6

## Typical Microwave Performance

### MA4SW410 INSERTION LOSS

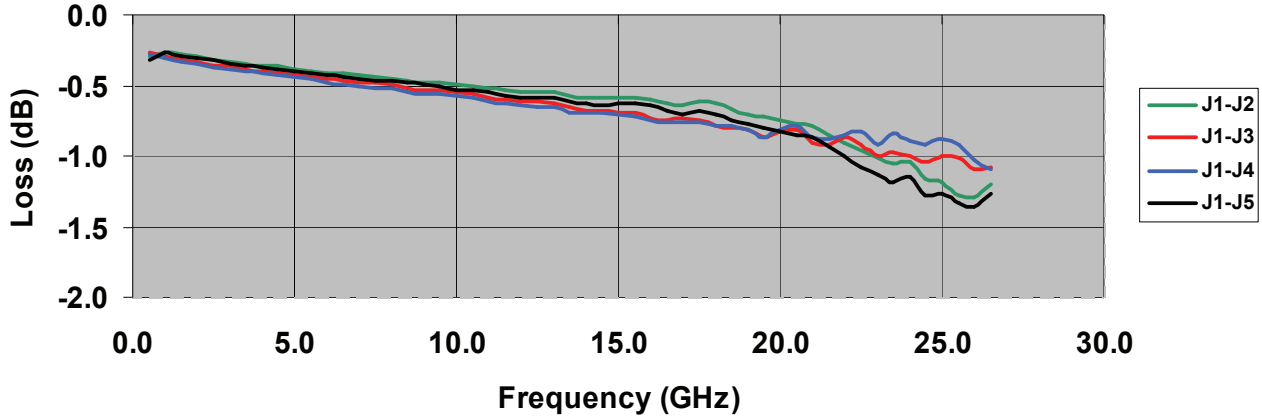

### MA4SW410 INPUT RETURN LOSS

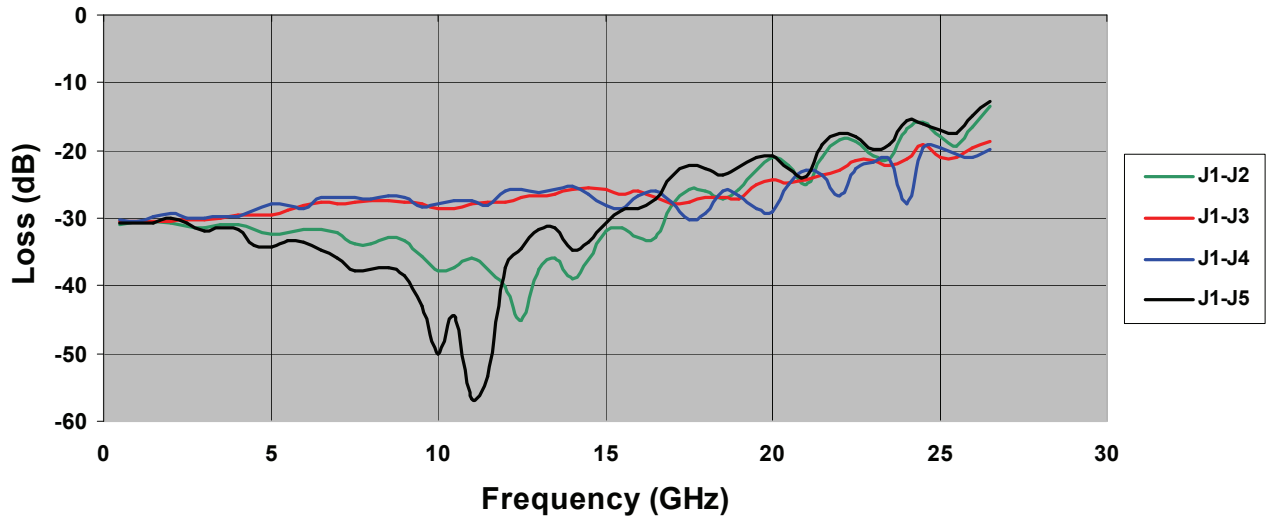

**ADVANCED:** Data Sheets contain information regarding a product M/A-COM is considering for development. Performance is based on target specifications, simulated results, and/or prototype measurements. Commitment to develop is not guaranteed.

**PRELIMINARY:** Data Sheets contain information regarding a product M/A-COM has under development. Performance is based on engineering tests. Specifications are typical. Mechanical outline has been fixed. Engineering samples and/or test data may be available. Commitment to produce in volume is not guaranteed.

- **North America** Tel: 800.366.2266 / Fax: 978.366.2266
- **Europe** Tel: 44.1908.574.200 / Fax: 44.1908.574.300
- **Asia/Pacific** Tel: 81.44.844.8296 / Fax: 81.44.844.8298

Visit [www.macom.com](http://www.macom.com) for additional data sheets and product information.

M/A-COM Inc. and its affiliates reserve the right to make changes to the product(s) or information contained herein without notice.

# MA4SW410

HMIC™ Silicon SP4T PIN Diode Switch  
RoHS Compliant

V6

## Typical Microwave Performance

### MA4SW410 OUTPUT RETURN LOSS

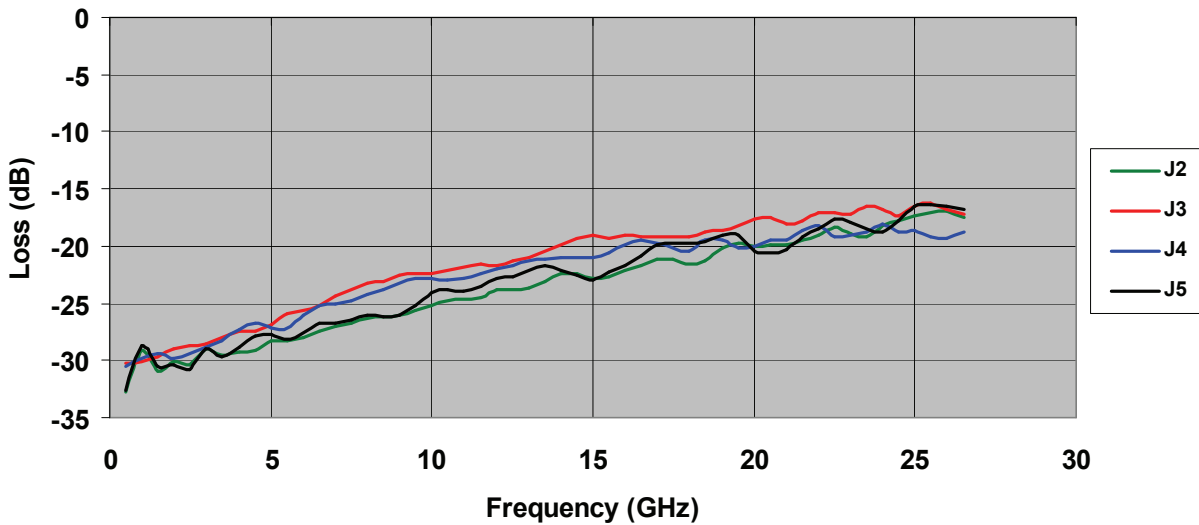

### MA4SW410 ISOLATION

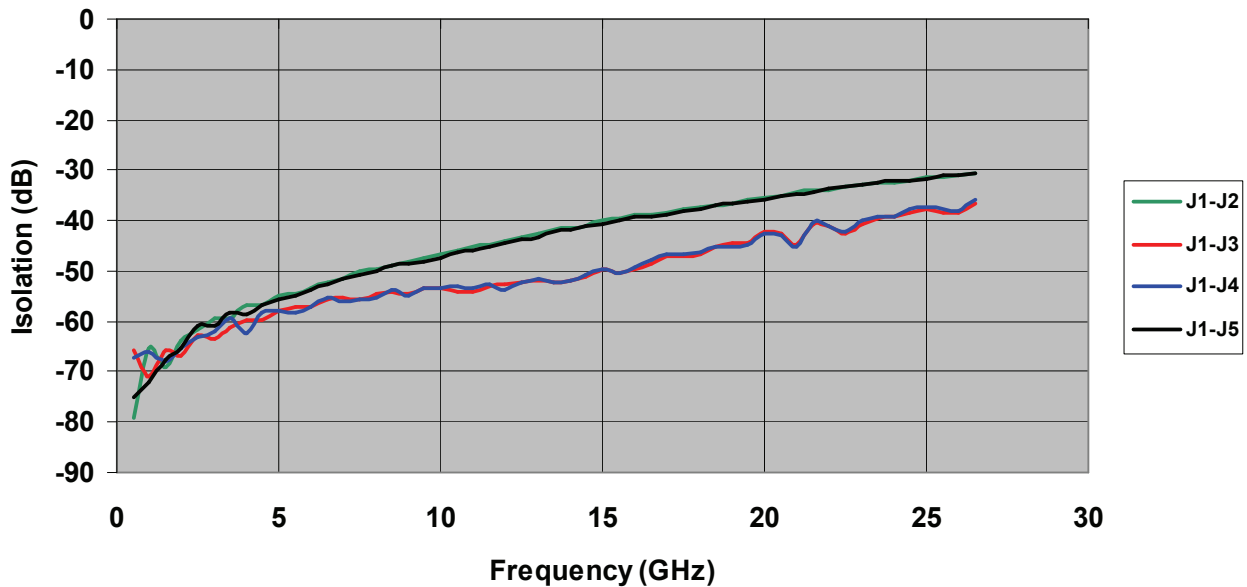

**ADVANCED:** Data Sheets contain information regarding a product M/A-COM is considering for development. Performance is based on target specifications, simulated results, and/or prototype measurements. Commitment to develop is not guaranteed.

**PRELIMINARY:** Data Sheets contain information regarding a product M/A-COM has under development. Performance is based on engineering tests. Specifications are typical. Mechanical outline has been fixed. Engineering samples and/or test data may be available. Commitment to produce in volume is not guaranteed.

- **North America** Tel: 800.366.2266 / Fax: 978.366.2266
- **Europe** Tel: 44.1908.574.200 / Fax: 44.1908.574.300
- **Asia/Pacific** Tel: 81.44.844.8296 / Fax: 81.44.844.8298

Visit [www.macom.com](http://www.macom.com) for additional data sheets and product information.

M/A-COM Inc. and its affiliates reserve the right to make changes to the product(s) or information contained herein without notice.

# MA4SW410

HMIC™ Silicon SP4T PIN Diode Switch  
RoHS Compliant

V6

## MA4SW410 Chip Dimensions

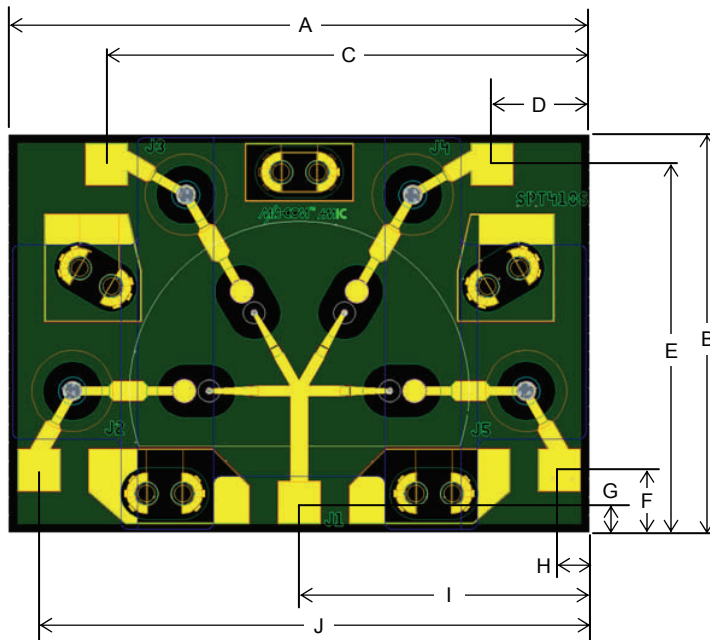

### Notes:

1. Topside and backside metallization is gold, 2.5  $\mu\text{m}$  thick

DIM	INCHES	MM
	NOMINAL	NOMINAL
A	.066	1.67
B	.047	1.19
C	.054	1.37
D	.012	0.31
E	.043	1.08
F	.009	0.22
G	.004	0.11
H	.004	0.11
I	.033	0.84
J	.061	1.56
Thickness	.005	.120
Bond Pads	.005X.005	0.120X.0120

All tolerances are  $\pm .0005$  inches

**ADVANCED:** Data Sheets contain information regarding a product M/A-COM is considering for development. Performance is based on target specifications, simulated results, and/or prototype measurements. Commitment to develop is not guaranteed.

**PRELIMINARY:** Data Sheets contain information regarding a product M/A-COM has under development. Performance is based on engineering tests. Specifications are typical. Mechanical outline has been fixed. Engineering samples and/or test data may be available. Commitment to produce in volume is not guaranteed.

- **North America** Tel: 800.366.2266 / Fax: 978.366.2266
- **Europe** Tel: 44.1908.574.200 / Fax: 44.1908.574.300
- **Asia/Pacific** Tel: 81.44.844.8296 / Fax: 81.44.844.8298

Visit [www.macom.com](http://www.macom.com) for additional data sheets and product information.

M/A-COM Inc. and its affiliates reserve the right to make changes to the product(s) or information contained herein without notice.

## MA4SW410

HMIC™ Silicon SP4T PIN Diode Switch  
RoHS Compliant

V6

### ASSEMBLY INSTRUCTIONS

**Cleanliness:** The chips should be handled in a clean environment free of dust and organic contamination.

**Electro-Static Sensitivity:** The MA4SW410 PIN diode switch is ESD sensitive and proper precautions should be taken to avoid damaging the chip. ESD rating is Class 0 (HBM) and Class C1 (CDM).

**Wire / Ribbon Bonding:** Thermosonic wedge bonding using 0.003" x 0.00025" ribbon or 0.001" diameter gold wire is recommended. A work stage temperature of 150°C – 200°C, tool tip temperature of 120°C – 150°C and a downward force of 18 to 22 grams should be used. If ultrasonic energy is necessary, it should be adjusted to the minimum level required to achieve a good bond. Excessive power or force will fracture the silicon beneath the bond pad causing it to lift. RF bond wires and ribbons should be kept as short as possible for optimum RF performance.

**Chip Mounting:** HMIC switches have Ti-Pt-Au backside metallization and can be mounted using a gold-tin eutectic solder or conductive epoxy. Mounting surface must be free of contamination and flat.

**Eutectic Die Attachment:** 80/20, gold-tin, solder is recommended. A re-flow oven or hot gas die bonder with a temperature setting of 290°C is normally used to melt the solder. The chip should not be exposed to temperatures greater than 320°C for more than 20 seconds. Typically no more than three seconds at peak temperature is required for attachment. RoHS compliant solders may also be used but solders rich in tin should be avoided as they will scavenge the backside gold and/or cause gold embrittlement.

**Epoxy Die Attachment:** A minimum amount of epoxy, 1–2 mils thick, should be used to attach chip. A thin epoxy fillet should be visible around the outer perimeter of the chip after placement. Epoxy cure time is typically 1 hour at 150°C.

**ADVANCED:** Data Sheets contain information regarding a product M/A-COM is considering for development. Performance is based on target specifications, simulated results, and/or prototype measurements. Commitment to develop is not guaranteed.

**PRELIMINARY:** Data Sheets contain information regarding a product M/A-COM has under development. Performance is based on engineering tests. Specifications are typical. Mechanical outline has been fixed. Engineering samples and/or test data may be available. Commitment to produce in volume is not guaranteed.

- **North America** Tel: 800.366.2266 / Fax: 978.366.2266
- **Europe** Tel: 44.1908.574.200 / Fax: 44.1908.574.300
- **Asia/Pacific** Tel: 81.44.844.8296 / Fax: 81.44.844.8298

Visit [www.macom.com](http://www.macom.com) for additional data sheets and product information.

*M/A-COM Inc. and its affiliates reserve the right to make changes to the product(s) or information contained herein without notice.*

Компания «Океан Электроники» предлагает заключение долгосрочных отношений при поставках импортных электронных компонентов на взаимовыгодных условиях!

Наши преимущества:

- Поставка оригинальных импортных электронных компонентов напрямую с производств Америки, Европы и Азии, а так же с крупнейших складов мира;
- Широкая линейка поставок активных и пассивных импортных электронных компонентов (более 30 млн. наименований);
- Поставка сложных, дефицитных, либо снятых с производства позиций;
- Оперативные сроки поставки под заказ (от 5 рабочих дней);
- Экспресс доставка в любую точку России;
- Помощь Конструкторского Отдела и консультации квалифицированных инженеров;
- Техническая поддержка проекта, помощь в подборе аналогов, поставка прототипов;
- Поставка электронных компонентов под контролем ВП;
- Система менеджмента качества сертифицирована по Международному стандарту ISO 9001;
- При необходимости вся продукция военного и аэрокосмического назначения проходит испытания и сертификацию в лаборатории (по согласованию с заказчиком);
- Поставка специализированных компонентов военного и аэрокосмического уровня качества (Xilinx, Altera, Analog Devices, Intersil, Interpoint, Microsemi, Actel, Aeroflex, Peregrine, VPT, Syfer, Eurofarad, Texas Instruments, MS Kennedy, Miteq, Cobham, E2V, MA-COM, Hittite, Mini-Circuits, General Dynamics и др.);

Компания «Океан Электроники» является официальным дистрибьютором и эксклюзивным представителем в России одного из крупнейших производителей разъемов военного и аэрокосмического назначения «JONHON», а так же официальным дистрибьютором и эксклюзивным представителем в России производителя высокотехнологичных и надежных решений для передачи СВЧ сигналов «FORSTAR».



## JONHON

«JONHON» (основан в 1970 г.)

Разъемы специального, военного и аэрокосмического назначения:

(Применяются в военной, авиационной, аэрокосмической, морской, железнодорожной, горно- и нефтедобывающей отраслях промышленности)

«FORSTAR» (основан в 1998 г.)

ВЧ соединители, коаксиальные кабели,  
кабельные сборки и микроволновые компоненты:

(Применяются в телекоммуникациях гражданского и специального назначения, в средствах связи, РЛС, а так же военной, авиационной и аэрокосмической отраслях промышленности).



Телефон: 8 (812) 309-75-97 (многоканальный)

Факс: 8 (812) 320-03-32

Электронная почта: [ocean@oceanchips.ru](mailto:ocean@oceanchips.ru)

Web: <http://oceanchips.ru/>

Адрес: 198099, г. Санкт-Петербург, ул. Калинина, д. 2, корп. 4, лит. А