

FEATURES

- 3 kV rms signal and power isolated CAN transceiver**
- isoPower* integrated isolated dc-to-dc converter**
- V_{IO} pin for 1.7 V to 5.5 V logic levels**
- ISO 11898-2:2016 compliant (CAN FD)**
- Data rates up to 12 Mbps for CAN FD**
- Low maximum loop propagation delay: 150 ns**
- Extended common-mode range (V_{CANx}): ±25 V**
- Bus fault protection: ±40 V on CANH and CANL pins**
- Low power standby support remote wake request**
- Extra isolated signal for control (such as termination switches)**
- Passes EN 55022 Class B by 6 dB**
- Slope control for reduced EMI**
- Safety and regulatory approvals**

VDE certificate of conformity, VDE V 0884-10 (pending)

V_{IORM} = 849 V_{PEAK}

UL: 5000 V rms for 1 minute per UL 1577 (pending)

CSA Component Acceptance Notice 5A (pending)

IEC 60950-1, IEC 61010-1

Creepage and clearance

7.8 mm minimum with 20-lead SOIC_W

High common-mode transient immunity: >75 kV/μs

ENHANCED PRODUCT FEATURES

Supports defense and aerospace applications (AQEC standard)

Military temperature range: -55°C to +105°C

Controlled manufacturing baseline

1 assembly/test site

Product change notification

Qualification data available on request

APPLICATIONS

CANOpen, DeviceNet, and other CAN bus implementations

Industrial automation

Military and aerospace (MILA) avionics for sensors, actuators, and engine control

GENERAL DESCRIPTION

The ADM3057E-EP is a 3 kV rms isolated controller area network (CAN) physical layer transceiver with integrated isolated dc-to-dc converter. The ADM3057E-EP meets flexible data rate (CAN FD) requirements for operation to 5 Mbps and higher and complies with the ISO 11898-2: 2016 standard. The ADM3057E-EP is capable of supporting data rates as high as 12 Mbps.

The device employs Analog Devices, Inc., *iCoupler*® technology to combine a 3-channel isolator, a CAN transceiver, and an Analog Devices *isoPower*® dc-to-dc converter into a single, surface-mount,

FUNCTIONAL BLOCK DIAGRAM

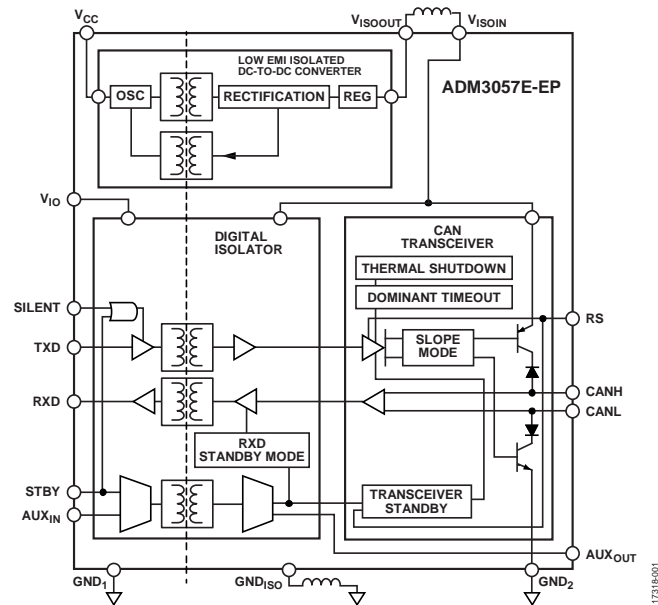

Figure 1.

small outline integrated circuit (SOIC) package. The device is powered by a single 5 V supply, realizing a fully isolated solution for CAN and CAN FD. Radiated emissions from the high frequency switching of the dc-to-dc converters are kept below EN 55022 Class B limits by continuous adjustments to the switching frequency.

The ADM3057E-EP provides complete isolation between the CAN controller and physical layer bus. Safety and regulatory approvals (pending) for 3 kV rms isolation voltage, 10 kV surge test, and 7.8 mm creepage and clearance ensure the ADM3057E-EP meets application reinforced isolation requirements.

Low propagation delays through the isolation support longer bus cables. Slope control mode is available for standard CAN at low data rates. Standby mode minimizes power consumption when the bus is idle or if the node goes offline. Silent mode allows the TXD input to be ignored for listen only mode.

Dominant timeout functionality protects against bus lockup in a fault condition. The current limiting and thermal shutdown features protect against output short circuits. The device is fully specified over a temperature range of -55°C to +105°C.

Additional application and technical information can be found in the [ADM3057E](#) data sheet.

Rev. 0

[Document Feedback](#)

Information furnished by Analog Devices is believed to be accurate and reliable. However, no responsibility is assumed by Analog Devices for its use, nor for any infringements of patents or other rights of third parties that may result from its use. Specifications subject to change without notice. No license is granted by implication or otherwise under any patent or patent rights of Analog Devices. Trademarks and registered trademarks are the property of their respective owners.

TABLE OF CONTENTS

Features	1	DIN V VDE V 0884-10 (VDE V 0884-10) Insulation	
Enhanced Product Features	1	Characteristics	9
Applications.....	1	Absolute Maximum Ratings	10
General Description	1	Thermal Resistance	10
Functional Block Diagram	1	ESD Caution.....	10
Revision History	2	Pin Configuration and Function Descriptions.....	11
Specifications.....	3	Operational Truth Table	12
Timing Specifications	5	Typical Performance Characteristics	13
Insulation and Safety Related Specifications	7	Test Circuits.....	17
Package Characteristics	7	Outline Dimensions	18
Regulatory Information.....	8	Ordering Guide	18

REVISION HISTORY

2/2019—Revision 0: Initial Version

SPECIFICATIONS

All voltages are relative to their respective ground. $4.5\text{ V} \leq V_{CC} \leq 5.5\text{ V}$, $1.7\text{ V} \leq V_{IO} \leq 5.5\text{ V}$, $-55^\circ\text{C} \leq T_A \leq +105^\circ\text{C}$, and STBY low, unless otherwise noted. Typical specifications are at $V_{CC} = V_{IO} = 5\text{ V}$ and $T_A = 25^\circ\text{C}$, unless otherwise noted.

Table 1.

Parameter	Symbol	Min	Typ	Max	Unit	Test Conditions/Comments
SUPPLY CURRENT						
Logic Side <i>iso</i> Power Current Standby	I_{CC}		13.5	30	mA	STBY high, AUX _{IN} low, load resistance (R_L) = 60 Ω
Recessive State (or Silent) Dominant State			27	40	mA	TXD and/or SILENT high, $R_L = 60\ \Omega$
70% Dominant/30% Recessive			180	260	mA	Fault condition, $R_L = 60\ \Omega$
1 Mbps			138		mA	Worst case, $R_L = 60\ \Omega$
5 Mbps			151	200	mA	
12 Mbps			177	220	mA	
Switching Frequency	f_{OSC}		180		MHz	Frequency hopping center
Logic Side <i>i</i> Coupler Current	I_{IO}					
Normal Mode			3.6	5	mA	TXD high, low or switching, AUX _{IN} low
Standby Mode			1.2	2	mA	STBY high
DRIVER						
Differential Outputs						See Figure 27
Recessive State, Normal Mode						TXD high, R_L and common-mode filter capacitor (C_F) open
CANH, CANL Voltage	V_{CANL} , V_{CANH}	2.0		3.0	V	
Differential Output Voltage	V_{OD}	-500		+50	mV	
Dominant State, Normal Mode						TXD and SILENT low, C_F open
CANH Voltage	V_{CANH}	2.75		4.5	V	$50\ \Omega \leq R_L \leq 65\ \Omega$
CANL Voltage	V_{CANL}	0.5		2.0	V	$50\ \Omega \leq R_L \leq 65\ \Omega$
Differential Output Voltage	V_{OD}	1.5		3.0	V	$50\ \Omega \leq R_L \leq 65\ \Omega$
		1.4		3.3	V	$45\ \Omega \leq R_L \leq 70\ \Omega$
		1.5		5.0	V	$R_L = 2240\ \Omega$
Standby Mode						STBY high, R_L and C_F open
CANH, CANL Voltage	V_{CANL} , V_{CANH}	-0.1		+0.1	V	
Differential Output Voltage	V_{OD}	-200		+200	mV	
Output Symmetry ($V_{ISOIN} - V_{CANH} - V_{CANL}$)	V_{SYM}	-0.55		+0.55	V	$R_L = 60\ \Omega$, $C_F = 4.7\text{ nF}$, RS low
Short-Circuit Current	$ I_{SC} $					R_L open
Absolute						
CANH				115	mA	$V_{CANH} = -3\text{ V}$
CANL				115	mA	$V_{CANL} = 18\text{ V}$
Steady State						
CANH				115	mA	$V_{CANH} = -24\text{ V}$
CANL				115	mA	$V_{CANL} = 24\text{ V}$
Logic Inputs (TXD, SILENT, STBY, AUX _{IN})						
Input Voltage						
High	V_{IH}	$0.65 \times V_{IO}$			V	
Low	V_{IL}			$0.35 \times V_{IO}$	V	
Complementary Metal-Oxide Semiconductor (CMOS) Logic	$ I_{IH} , I_{IL} $			10	μA	Input high or low
Input Currents						

Parameter	Symbol	Min	Typ	Max	Unit	Test Conditions/Comments
RECEIVER						
Differential Inputs						
Differential Input Voltage Range	V_{ID}					See Figure 28, C_{RXD} open, $-25\text{ V} < V_{CANL}, V_{CANH} < +25\text{ V}$
Recessive		-1.0		+0.5	V	
Dominant		-1.0		+0.4	V	STBY high
		0.9		5.0	V	
		1.15		5.0	V	STBY high
Input Voltage Hysteresis	V_{HYS}		150		mV	
Unpowered Input Leakage Current	$ I_{IN(OFF)} $			10	μA	$V_{CANH}, V_{CANL} = 5\text{ V}, V_{CC} = 0\text{ V}$
Input Resistance						
CANH, CANL	R_{INH}, R_{INL}	6		25	$\text{k}\Omega$	
Differential	R_{DIFF}	20		100	$\text{k}\Omega$	
Matching	m_R	-0.03		+0.03	Ω/Ω	$m_R = 2 \times (R_{INH} - R_{INL}) / (R_{INH} + R_{INL})$
Input Capacitance						
CANH, CANL	C_{INH}, C_{INL}		35		pF	
Differential	C_{DIFF}		12		pF	
Logic Outputs (RXD, AUX _{OUT})						
Output Voltage						
Low	V_{OL}		0.2	0.4	V	Output current (I_{OUT}) = 2 mA
High	V_{OH}				V	
RXD		$V_{IO} - 0.2$			V	$I_{OUT} = -2\text{ mA}$
AUX _{OUT}		+2.4			V	$I_{OUT} = -2\text{ mA}$
Short-Circuit Current						
RXD	I_{OS}	7		85	mA	Output voltage (V_{OUT}) = GND ₁ or V_{IO}
COMMON-MODE TRANSIENT IMMUNITY¹						
Input High, Recessive	$ CM_H $	75	100		kV/ μs	Common-mode voltage (V_{CM}) $\geq 1\text{ kV}$, transient magnitude $\geq 800\text{ V}$ $V_{IN} = V_{IO}$ (AUX _{IN} , TXD) or CANH/CANL recessive
Input Low, Dominant	$ CM_L $	75	100		kV/ μs	$V_{IN} = 0\text{ V}$ (AUX _{IN} , TXD) or CANH/CANL dominant
SLOPE CONTROL						
Input Voltage for Standby Mode	V_{STB}	4.0			V	
Current for Slope Control Mode	I_{SLOPE}			-240	μA	RS voltage (V_{RS}) = 0 V
Slope Control Mode Voltage	V_{SLOPE}	2.1			V	RS current (I_{RS}) = 10 μA
Input Voltage for High Speed Mode	V_{HS}		1		V	

¹ $|CM_H|$ is the maximum common-mode voltage slew rate that can be sustained while maintaining AUX_{OUT} $\geq 2.4\text{ V}$, CANH/CANL recessive, or RXD $\geq V_{IO} - 0.2\text{ V}$. $|CM_L|$ is the maximum common-mode voltage slew rate that can be sustained while maintaining AUX_{OUT} $\leq 0.4\text{ V}$, CANH/CANL dominant, or RXD $\leq 0.4\text{ V}$. The common-mode voltage slew rates apply to both rising and falling common-mode voltage edges.

TIMING SPECIFICATIONS

All voltages are relative to their respective ground. $4.5\text{ V} \leq V_{CC} \leq 5.5\text{ V}$, $1.7\text{ V} \leq V_{IO} \leq 5.5\text{ V}$, $-55^\circ\text{C} \leq T_A \leq +105^\circ\text{C}$, and STBY low, unless otherwise noted. Typical specifications are at $V_{CC} = V_{IO} = 5\text{ V}$ and $T_A = 25^\circ\text{C}$, unless otherwise noted.

Table 2.

Parameter	Symbol	Min	Typ	Max	Unit	Test Conditions/Comments
DRIVER						
Maximum Data Rate		12			Mbps	SILENT low, bit time on the TXD pin as transmitted by the CAN controller ($t_{\text{BIT_TXD}} = 200\text{ ns}$, see Figure 2 and Figure 29, slope resistance ($R_{\text{SLOPE}} = 0\ \Omega$, $R_L = 60\ \Omega$, load capacitance ($C_L = 100\text{ pF}$)
Propagation Delay from TXD to Bus (Recessive to Dominant)	$t_{\text{TXD_DOM}}$		35	60	ns	
Propagation Delay from TXD to Bus (Dominant to Recessive)	$t_{\text{TXD_REC}}$		46	70	ns	
Transmit Dominant Timeout	t_{DT}	1175		4000	μs	TXD low, see Figure 5
RECEIVER						
Falling Edge Loop Propagation Delay (TXD to RXD)	$t_{\text{LOOP_FALL}}$					SILENT low, see Figure 2 and Figure 29, $R_L = 60\ \Omega$, $C_L = 100\text{ pF}$, RXD capacitance ($C_{\text{RXD}} = 15\text{ pF}$)
Full Speed Mode				150	ns	$R_{\text{SLOPE}} = 0\ \Omega$, $t_{\text{BIT_TXD}} = 200\text{ ns}$
Slope Control Mode				300	ns	$R_{\text{SLOPE}} = 47\text{ k}\Omega$, $t_{\text{BIT_TXD}} = 1\ \mu\text{s}$
Rising Edge Loop Propagation Delay (TXD to RXD)	$t_{\text{LOOP_RISE}}$					
Full Speed Mode				150	ns	$R_{\text{SLOPE}} = 0\ \Omega$, $t_{\text{BIT_TXD}} = 200\text{ ns}$
Slope Control Mode				300	ns	$R_{\text{SLOPE}} = 47\text{ k}\Omega$, $t_{\text{BIT_TXD}} = 1\ \mu\text{s}$
Loop Delay Symmetry (Minimum Recessive Bit Width)	$t_{\text{BIT_RXD}}$					
2 Mbps		450		550	ns	$t_{\text{BIT_TXD}} = 500\text{ ns}$
5 Mbps		160		220	ns	$t_{\text{BIT_TXD}} = 200\text{ ns}$
8 Mbps		85		140	ns	$t_{\text{BIT_TXD}} = 125\text{ ns}$
12 Mbps		50		91.6	ns	$t_{\text{BIT_TXD}} = 83.3\text{ ns}$
CANH, CANL SLEW RATE	SR		7		V/ μs	SILENT low, see Figure 29, $R_L = 60\ \Omega$, $C_L = 100\text{ pF}$, $R_{\text{SLOPE}} = 47\text{ k}\Omega$
STANDBY MODE						
Minimum Pulse Width Detected (Receiver Filter Time)	t_{FILTER}	1		5	μs	STBY high, see Figure 4
Wake-Up Pattern Detection Reset Time	t_{WUPR}	1175		4000	μs	STBY high, see Figure 4
Normal Mode to Standby Mode Time	$t_{\text{STBY_ON}}$			25	μs	
Standby Mode to Normal Mode Time	$t_{\text{STBY_OFF}}$			25	μs	Time until RXD valid
AUXILIARY SIGNAL						
Maximum Switching Rate	f_{AUX}	20			kHz	
AUX _{IN} to AUX _{OUT} Propagation Delay	t_{AUX}			25	μs	
SILENT MODE						
Normal Mode to Silent Mode Time	$t_{\text{SILENT_ON}}$		40	100	ns	TXD low, $R_{\text{SLOPE}} = 0\ \Omega$, see Figure 3
Silent Mode to Normal Mode Time	$t_{\text{SILENT_OFF}}$		50	100	ns	TXD low, $R_{\text{SLOPE}} = 0\ \Omega$, see Figure 3

Timing Diagrams

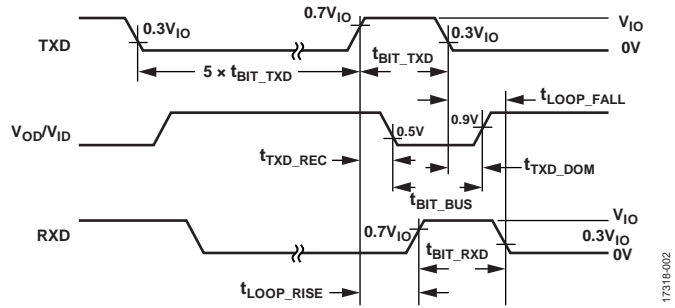

Figure 2. Transceiver Timing Diagram

17318-002

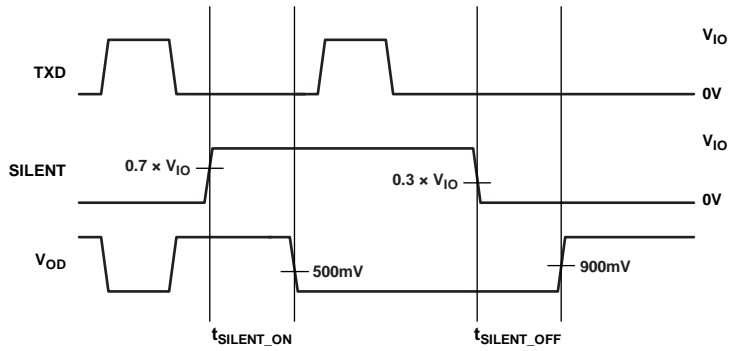

Figure 3. Silent Mode Timing Diagram

17318-015

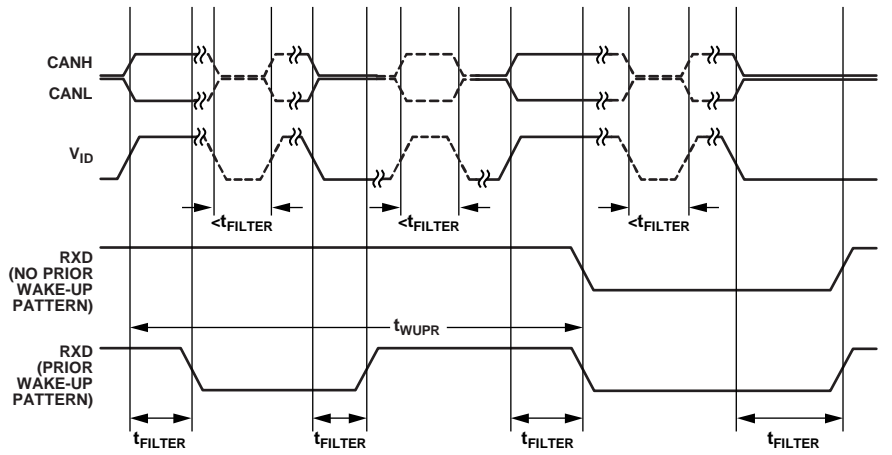

Figure 4. Wake-Up Pattern Detection and Filtered RXD in Standby Mode Timing Diagram

17318-004

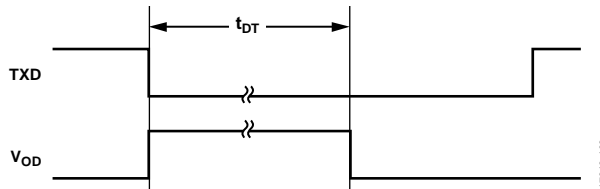

Figure 5. Dominant Timeout

17318-103

INSULATION AND SAFETY RELATED SPECIFICATIONS

For additional information, see www.analog.com/icouplersafety.

Table 3.

Parameter	Symbol	Value	Unit	Test Conditions/Comments
Rated Dielectric Insulation Voltage		3000	V rms	1-minute duration
Minimum External Air Gap (Clearance)	L (I01)	7.8	mm min	Measured from input terminals to output terminals, shortest distance through air
Minimum External Tracking (Creepage)	L (I02)	7.8	mm min	Measured from input terminals to output terminals, shortest distance path along body
Minimum Clearance in the Plane of the Printed Circuit Board (PCB Clearance)	L (PCB)	7.8	mm min	Measured from input terminals to output terminals, shortest distance through air, line of sight, in the PCB mounting plane
Minimum Internal Gap (Internal Clearance)		21	µm min	Insulation distance through insulation
Tracking Resistance (Comparative Tracking Index)	CTI	>600	V	IEC 60112
Material Group		I		Material Group (IEC 60664-1)

PACKAGE CHARACTERISTICS

Table 4.

Parameter	Symbol	Min	Typ	Max	Unit	Test Conditions/Comments
Resistance (Input to Output) ¹	R _{I-O}		10 ¹³		Ω	
Capacitance (Input to Output) ¹	C _{I-O}		3.7		pF	f = 1 MHz
Input Capacitance ²	C _I		4.0		pF	

¹ The device is considered a 2-terminal device: Pin 1 through Pin 10 are shorted together, and Pin 11 through Pin 20 are shorted together.

² Input capacitance is from any input data pin to ground.

REGULATORY INFORMATION

See Table 9 for details regarding maximum working voltages for specific cross isolation waveforms and insulation levels. The ADM3057E-EP is approved or pending approval by the organizations listed in Table 5.

Table 5.

UL (Pending)¹	CSA (Pending)	VDE (Pending)²	CQC (Pending)
Recognized Under UL 1577 Component Recognition Program Single Protection, 3000 V rms Isolation Voltage File E214100	Approved under CSA Component Acceptance Notice 5A CSA 60950-1-07+A1+A2 and IEC 60950-1, second edition, +A1+A2 Basic insulation at 780 V rms (1103 V _{PEAK}) Reinforced insulation at 390 V rms (552 V _{PEAK}) IEC 60601-1 Edition 3.1: Basic insulation (1 MOPP), 490 V rms (693 V _{PEAK}) Reinforced insulation (2 MOPP), 250 V rms (353 V _{PEAK}) CSA 61010-1-12 and IEC 61010-1 third edition Basic insulation at 300 V rms mains, 780 V secondary (1103 V _{PEAK}) Reinforced insulation at 300 V rms mains, 390 V secondary (552 V _{PEAK}) File 205078	DIN V VDE V 0884-10 (VDE V 0884-10):2006-12 Reinforced insulation 849 V _{PEAK} , surge isolation voltage (V _{IOTM}) = 6000 V _{PEAK} File 2471900-4880-0001	Certified under CQC11-471543-2012 GB4943.1-2011: basic insulation at 780 V rms (1103 V _{PEAK}) Reinforced insulation at 390 V rms (552 V _{PEAK}) File (pending)

¹ In accordance with UL 1577, each ADM3057E-EP is proof tested by applying an insulation test voltage ≥ 3600 V rms for 1 sec.

² In accordance with DIN V VDE V 0884-10, each ADM3057E-EP is proof tested by applying an insulation test voltage ≥ 1592 V_{PEAK} for 1 sec (partial discharge detection limit = 5 pC). The * marking branded on the component designates DIN V VDE V 0884-10 approval.

DIN V VDE V 0884-10 (VDE V 0884-10) INSULATION CHARACTERISTICS

These isolators are suitable for reinforced electrical isolation only within the safety limit data. The protective circuits ensure the maintenance of the safety data. The asterisk (*) marking on packages denotes DIN V VDE V 0884-10 approval.

Table 6. VDE Characteristics

Description	Test Conditions/Comments	Symbol	Characteristic	Unit
Installation Classification per DIN VDE 0110 For Rated Mains Voltage ≤ 150 V rms For Rated Mains Voltage ≤ 300 V rms For Rated Mains Voltage ≤ 400 V rms			I to IV I to IV I to III	
Climatic Classification			55/105/21	
Pollution Degree per DIN VDE 0110, Table 1			2	
Maximum Working Insulation Voltage		V_{IORM}	849	V_{PEAK}
Input to Output Test Voltage, Method B1	$V_{IORM} \times 1.875 = V_{PR}$, 100% production test, $t_m = 1$ sec, partial discharge < 5 pC	$V_{pd(m)}$	1592	V_{PEAK}
Input to Output Test Voltage, Method A After Environmental Tests Subgroup 1	$V_{IORM} \times 1.5 = V_{pd(m)}$, $t_{ini} = 60$ sec, $t_m = 10$ sec, partial discharge < 5 pC	$V_{pd(m)}$	1273	V_{PEAK}
After Input or Safety Test Subgroup 2 and Subgroup 3	$V_{IORM} \times 1.2 = V_{pd(m)}$, $t_{ini} = 60$ sec, $t_m = 10$ sec, partial discharge < 5 pC	$V_{pd(m)}$	1018	V_{PEAK}
Highest Allowable Overvoltage	Transient overvoltage, $t_{TR} = 10$ sec	V_{IOTM}	6000	V_{PEAK}
Surge Isolation Voltage Reinforced	$V_{IOSM(TEST)} = 10$ kV, 1.2 μs rise time, 50 μs, 50% fall time	V_{IOSM}	6000	V_{PEAK}
Safety Limiting Values	Maximum value allowed in the event of a failure (see Figure 6)			
Case Temperature		T_S	150	°C
Total Power Dissipation at 25°C		P_S	2.35	W
Insulation Resistance at T_S	$V_{IO} = 500$ V	R_S	>10 ⁹	Ω

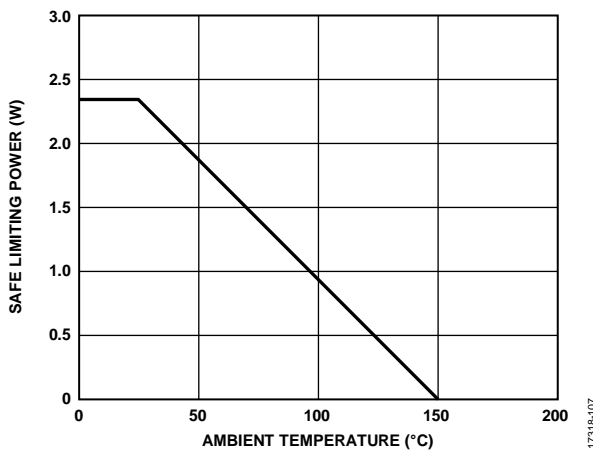

Figure 6. Thermal Derating Curve, Dependence of Safety Limiting Values with Ambient Temperature per DIN V VDE V 0884-10

ABSOLUTE MAXIMUM RATINGS

Pin voltages with respect to GND_x are on the same side, unless otherwise noted.

Table 7.

Parameter	Rating
V _{CC}	–0.5 V to +6 V
V _{IO}	–0.5 V to +6 V
Logic Side Input/Output: TXD, RXD, AUX _{IN} , SILENT, STBY	–0.5 V to V _{IO} + 0.5 V
CANH, CANL	–40 V to +40 V
AUX _{OUT} , RS	–0.5 V to V _{ISOIN} + 0.5 V
Operating Temperature Range	–55°C to +105°C
Storage Temperature Range	–65°C to +150°C
Junction Temperature (T _J Maximum)	150°C
Power Dissipation	(T _J maximum – T _A)/θ _{JA}
Electrostatic Discharge (ESD)	
IEC 61000-4-2, CANH/CANL	
Across Isolation Barrier to GND ₁	±8 kV
Contact Discharge to GND ₂	±8 kV
Air Discharge to GND ₂	±15 kV
Human Body Model (HBM), All Pins, 1.5 kΩ, 100 pF	4 kV
Moisture Sensitivity Level (MSL)	MSL3

Stresses at or above those listed under Absolute Maximum Ratings may cause permanent damage to the product. This is a stress rating only; functional operation of the product at these or any other conditions above those indicated in the operational section of this specification is not implied. Operation beyond the maximum operating conditions for extended periods may affect product reliability.

Table 9. Maximum Continuous Working Voltage¹

Parameter	Rating	Unit	Constraint
AC Voltage			
Bipolar Waveform			
Basic Insulation	566	V _{PEAK}	Lifetime limited by insulation lifetime per VDE-0884-11
Reinforced Insulation	467	V _{PEAK}	Lifetime limited by insulation lifetime per VDE-0884-11
Unipolar Waveform			
Basic Insulation	1131	V _{PEAK}	Lifetime limited by insulation lifetime per VDE-0884-11
Reinforced Insulation	933	V _{PEAK}	Lifetime limited by insulation lifetime per VDE-0884-11
DC Voltage			
Basic Insulation	1560	V _{PEAK}	Lifetime limited by package creepage per IEC 60664-1
Reinforced Insulation	780	V _{PEAK}	Lifetime limited by package creepage per IEC 60664-1

¹ Maximum continuous working voltage refers to the continuous voltage magnitude imposed across the isolation barrier. See the ADM3057E data sheet for more details.

THERMAL RESISTANCE

Thermal performance is directly linked to PCB design and operating environment. Careful attention to PCB thermal design is required.

The thermal resistance value specified in Table 8 is simulated based on JEDEC specifications (unless specified otherwise) and must be used in compliance with JESD51-12.

Table 8. Thermal Resistance

Package Type	θ _{JA}	Unit
RW-20 ¹	53	°C/W

¹ The θ_{JA} value is based on simulations of a device mounted on a JEDEC standard, 4-layer board with fine width traces and still air. See the ADM3057E data sheet for thermal model definitions.

ESD CAUTION



ESD (electrostatic discharge) sensitive device. Charged devices and circuit boards can discharge without detection. Although this product features patented or proprietary protection circuitry, damage may occur on devices subjected to high energy ESD. Therefore, proper ESD precautions should be taken to avoid performance degradation or loss of functionality.

PIN CONFIGURATION AND FUNCTION DESCRIPTIONS

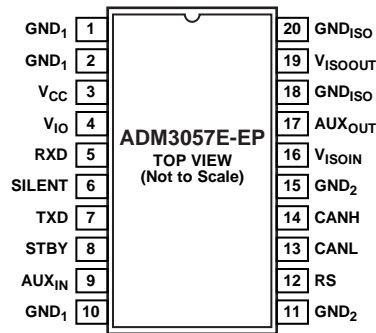

Figure 7. Pin Configuration

Table 10. Pin Function Descriptions

Pin No.	Mnemonic	Description
1, 2, 10	GND ₁	Ground, Logic Side.
3	V _{CC}	<i>iso</i> Power Power Supply, 4.5 V to 5.5 V. This pin requires 0.1 μ F and 10 μ F decoupling capacitors.
4	V _{IO}	<i>i</i> Coupler Power Supply, 1.7 V to 5.5 V. This pin requires 0.01 μ F and 0.1 μ F decoupling capacitors.
5	RXD	Receiver Output Data.
6	SILENT	Silent Mode Select with Input High. Bring this input low or leave the pin unconnected (internal pull-down) for normal mode.
7	TXD	Driver Input Data. This pin has a weak internal pull-up resistor to V _{IO} .
8	STBY	Standby Mode Select with Input High. Bring this input low or leave the pin unconnected (internal pull-down) for normal mode.
9	AUX _{IN}	Auxiliary Channel Input. This pin sets the AUX _{OUT} output.
11, 15	GND ₂	Ground, Bus Side.
12	RS	Slope Control Pin. Short this pin to ground for full speed operation or use a weak pull-down resistor (for example, 47 k Ω) for slope control mode. An input high signal places the CAN transceiver in standby mode.
13	CANL	CAN Low Input/Output.
14	CANH	CAN High Input/Output.
16	V _{ISOIN}	Isolated Power Supply Input for the CAN Transceiver Bus Side Digital Isolator. This pin requires 0.01 μ F and 0.1 μ F decoupling capacitors.
17	AUX _{OUT}	Isolated Auxiliary Channel Output. The state of AUX _{OUT} is latched when STBY is high. By default, AUX _{OUT} is low at startup or when V _{IO} is unpowered.
18, 20	GND _{ISO}	Ground for the Isolated DC-to-DC Converter. Connect these pins together through one ferrite bead to PCB ground (bus side).
19	V _{ISOOUT}	Isolated Power Supply Output. This pin requires 0.22 μ F and 10 μ F capacitors to GND _{ISO} . Connect this pin through a ferrite bead and short the PCB trace to V _{ISOIN} for operation.

OPERATIONAL TRUTH TABLE

Table 11. Truth Table

Power		Inputs ^{1,2}					Mode	Outputs ²		Input/Output
V _{CC}	V _{IO}	TXD	SILENT	STBY	AUX _{IN}	RS		RXD ³	AUX _{OUT}	CANH/CANL
On	On	Low	Low	Low	Low	Low/ pull-down	Normal/ slope mode	Low	Low	Dominant ⁴
On	On	Low	Low	Low	High	Low/ pull-down	Normal/ slope mode	Low	High	Dominant ⁴
On	On	High	Low	Low	Low	Low/ pull-down	Normal/ slope mode	High/per bus	Low	Recessive/set by bus
On	On	High	Low	Low	High	Low/ pull-down	Normal/ slope mode	High/per bus	High	Recessive/set by bus
On	On	X	High	Low	Low	X	Listen only	High/per bus	Low	Recessive/set by bus
On	On	X	High	Low	High	X	Listen only	High/per bus	High	Recessive/set by bus
On	On	X	X	High	X	X	Standby	High/WUP/filtered	Last state	Bias to GND ₂ /set by bus
On	On	X	X	X	Low	Pull-up	Standby ⁵	High/WUP/filtered	Low	Bias to GND ₂ /set by bus
On	On	X	X	X	High	Pull-up	Standby ⁵	High/WUP/filtered	High	Bias to GND ₂ /set by bus
On	Off	Z	Z	Z	Z	Low/ pull-down	Normal/ slope mode	Z	Low	Recessive/set by bus
Off	On	X	X	X	X	X	Transceiver off	High	Z	High impedance/set by bus
Off	Off	Z	Z	Z	Z	Z	Transceiver off	Z	Z	High impedance/set by bus

¹ X means irrelevant.

² Z means high impedance within one diode drop of ground.

³ WUP means remote wake-up pattern.

⁴ Limited by t_{DR}.

⁵ RS can only set the transceiver to standby mode. RS does not control the digital isolator.

TYPICAL PERFORMANCE CHARACTERISTICS

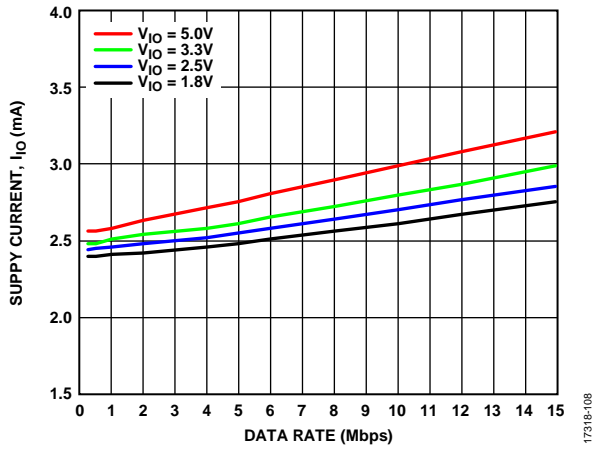

Figure 8. Supply Current, I_{IO} vs. Data Rate

17318-108

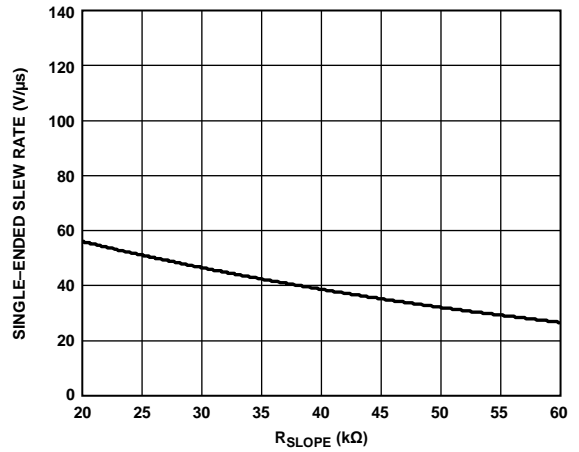

Figure 11. Single-Ended Slew Rate vs. R_{SLOPE}

17318-111

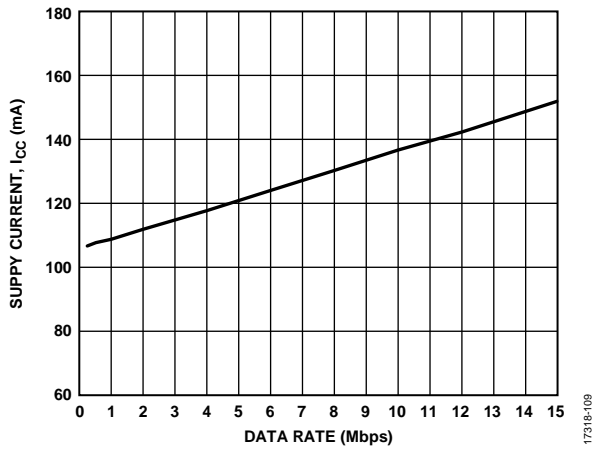

Figure 9. Supply Current, I_{CC} vs. Data Rate

17318-109

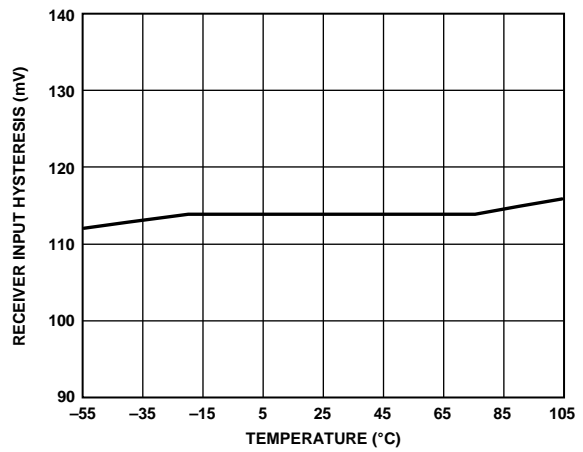

Figure 12. Receiver Input Hysteresis vs. Temperature

17318-112

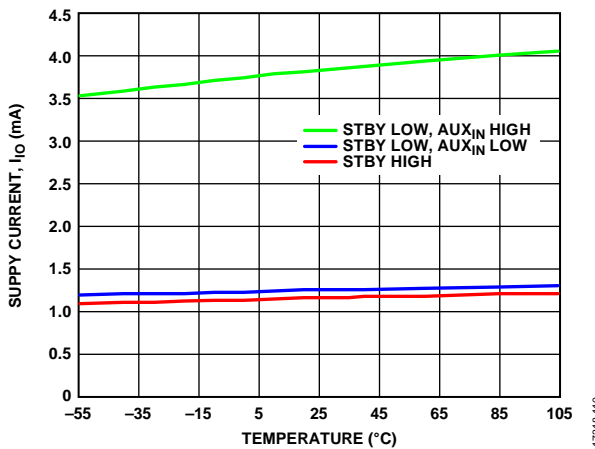

Figure 10. Supply Current, I_{IO} vs. Temperature (Inputs Idle)

17318-110

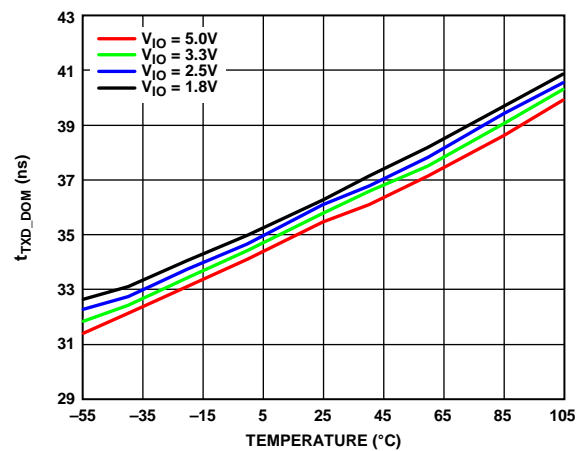

Figure 13. t_{TXD_DOM} vs. Temperature

17318-113

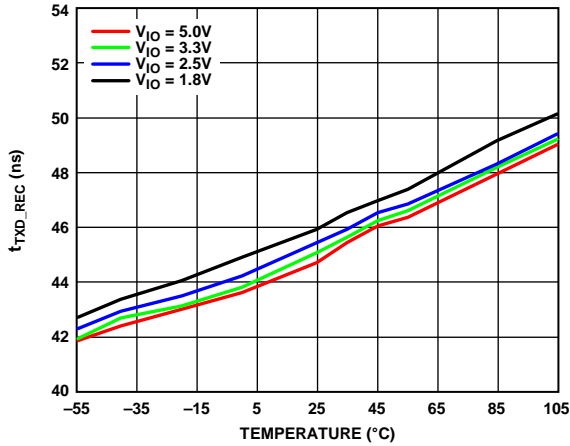

Figure 14. t_{TXD_REC} vs. Temperature

17318-114

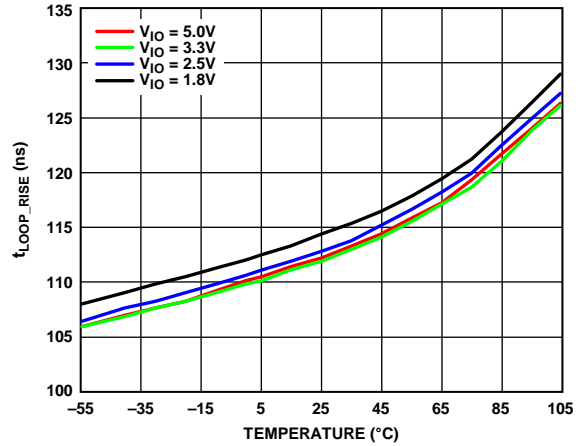

Figure 17. t_{LOOP_RISE} vs. Temperature ($R_{SLOPE} = 0 \Omega$)

17318-117

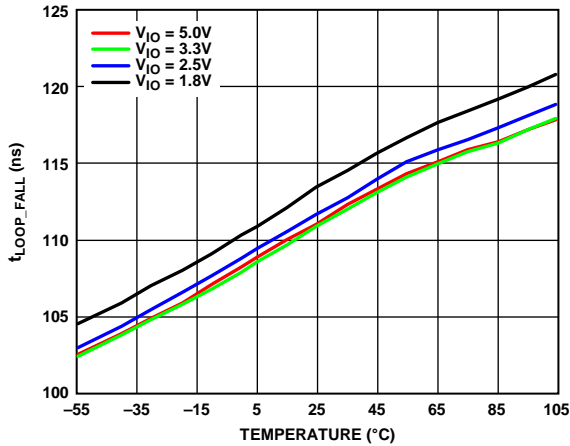

Figure 15. t_{LOOP_FALL} vs. Temperature ($R_{SLOPE} = 0 \Omega$)

17318-115

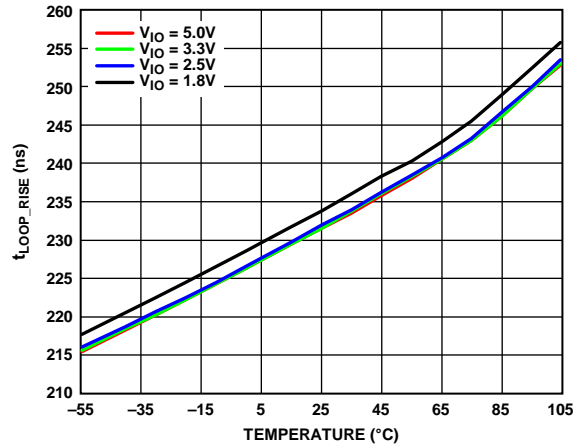

Figure 18. t_{LOOP_RISE} vs. Temperature ($R_{SLOPE} = 47 k\Omega$)

17318-118

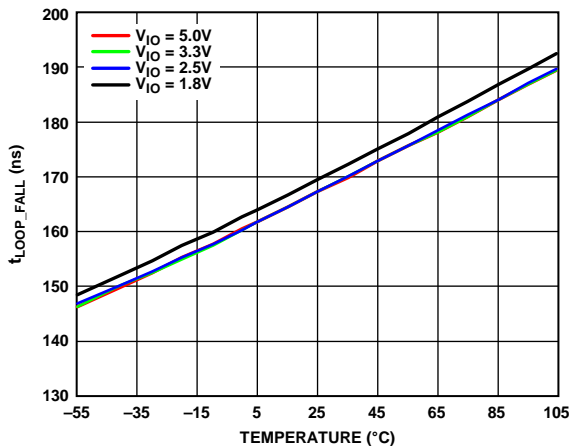

Figure 16. t_{LOOP_FALL} vs. Temperature ($R_{SLOPE} = 47 k\Omega$)

17318-116

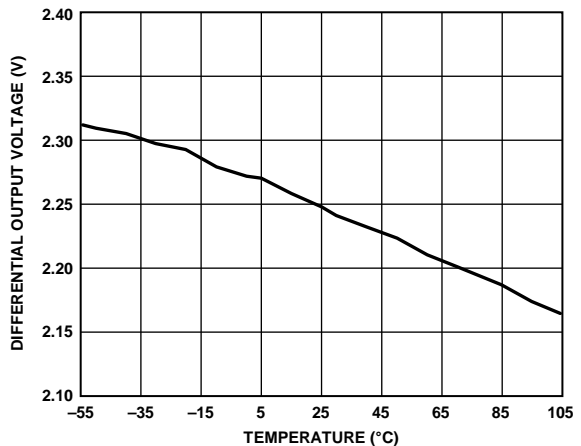

Figure 19. Differential Output Voltage (V_{OD}) vs. Temperature

17318-119

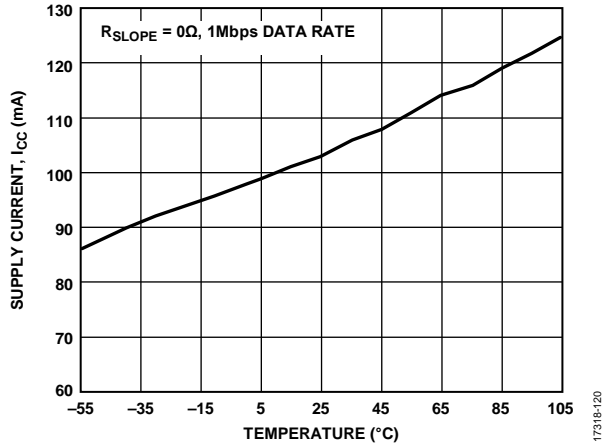

Figure 20. Supply Current, I_{CC} vs. Temperature

17318-120

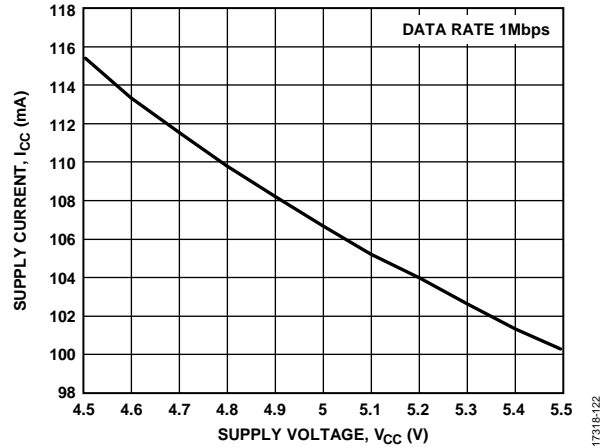

Figure 22. Supply Current, I_{CC} vs. Supply Voltage, V_{CC} , $R_S = 0\ \Omega$, 1 Mbps

17318-122

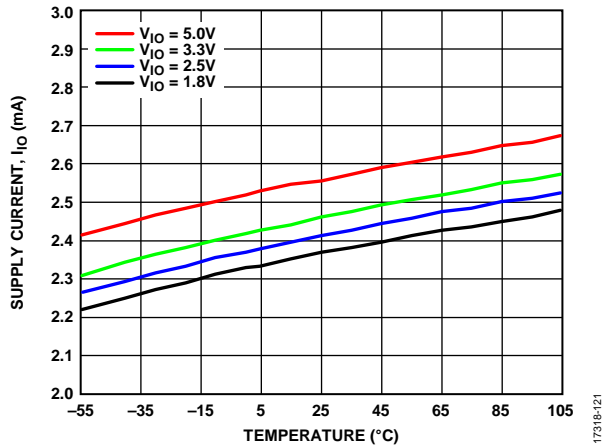

Figure 21. Supply Current, I_{IO} vs. Temperature, $R_S = 0\ \Omega$, 1 Mbps

17318-121

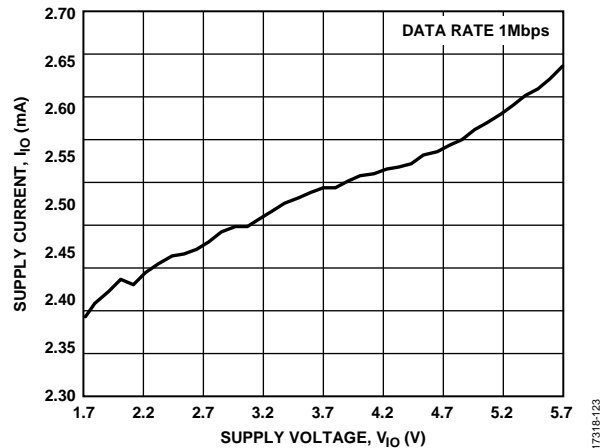

Figure 23. Supply Current, I_{IO} vs. Supply Voltage, V_{IO} , Data Rate = 1 Mbps

17318-123

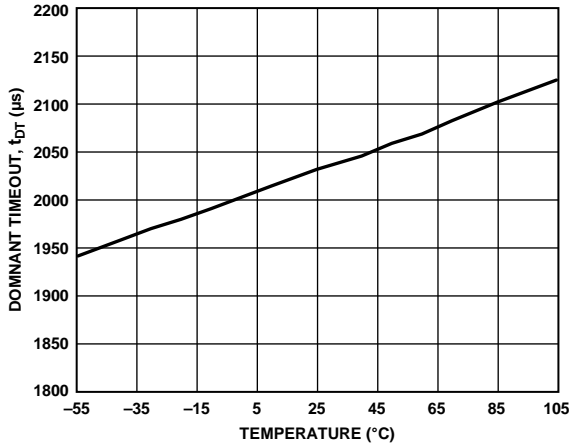

Figure 24. Dominant Timeout, t_{DT} vs. Temperature

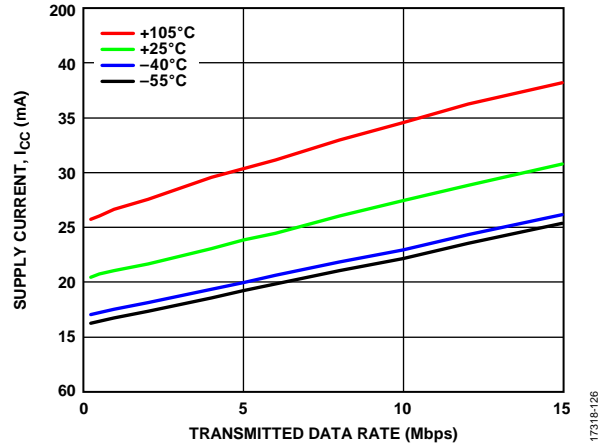

Figure 26. Supply Current, I_{CC} vs. Transmitted Data Rate

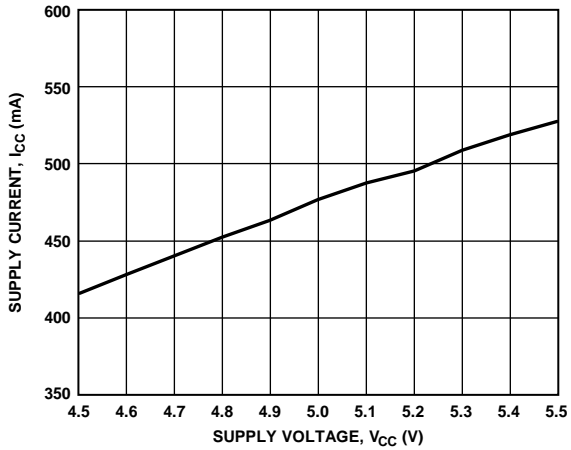

Figure 25. Supply Current, I_{CC} vs. Supply Voltage, V_{CC}
(V_{ISOOUT} Shorted to GND_{ISO})

17318-124

17318-126

17318-125

TEST CIRCUITS

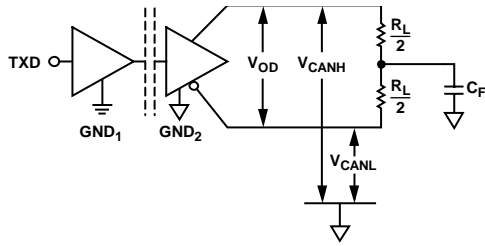

Figure 27. Driver Voltage Measurement

17318-008

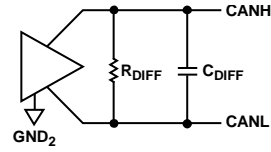

Figure 30. R_{DIFF} and C_{DIFF} Measured in Recessive State, Bus Disconnected

17318-011

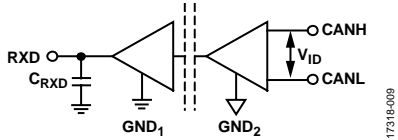

Figure 28. Receiver Voltage Measurement

17318-009

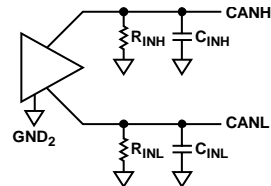
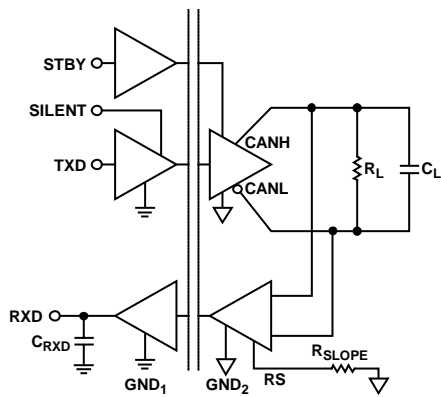

Figure 31. R_{INx} and C_{INx} Measured in Recessive State, Bus Disconnected

17318-012



NOTES
1. 1% TOLERANCE FOR ALL RESISTORS AND CAPACITORS.

Figure 29. Switching Characteristics Measurements

17318-010

OUTLINE DIMENSIONS

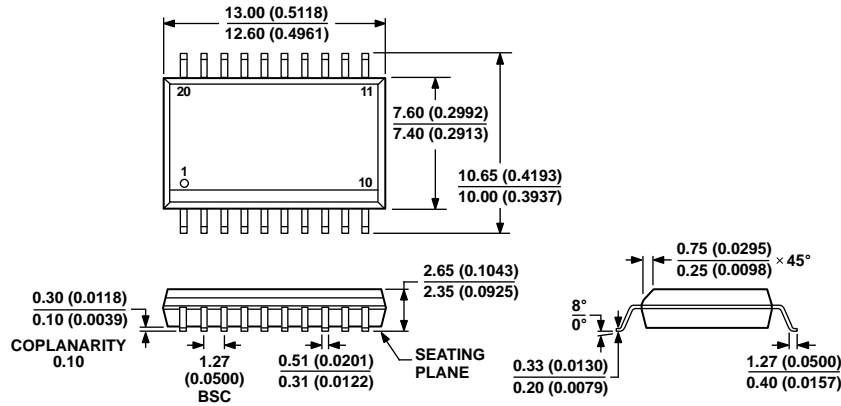

COMPLIANT TO JEDEC STANDARDS MS-013-AC
 CONTROLLING DIMENSIONS ARE IN MILLIMETERS; INCH DIMENSIONS
 (IN PARENTHESES) ARE ROUNDED-OFF MILLIMETER EQUIVALENTS FOR
 REFERENCE ONLY AND ARE NOT APPROPRIATE FOR USE IN DESIGN.

Figure 32. 20-Lead Standard Small Outline Package [SOIC_W]
 Wide Body
 (RW-20)

Dimensions shown in millimeters and (inches)

06-07-2006-A

ORDERING GUIDE

Model ^{1,2}	Temperature Range	Package Description	Package Option
ADM3057ETRWZ-EP	-55°C to +105°C	20-Lead Standard Small Outline Package [SOIC_W]	RW-20
ADM3057ETRWZ-EP-RL	-55°C to +105°C	20-Lead Standard Small Outline Package [SOIC_W]	RW-20
EVAL-ADM3055EEBZ		ADM3055E Evaluation Board	

¹ Z = RoHS Compliant Part.

² Use the [EVAL-ADM3055EEBZ](#) evaluation board to evaluate the ADM3057E-EP.

Компания «Океан Электроники» предлагает заключение долгосрочных отношений при поставках импортных электронных компонентов на взаимовыгодных условиях!

Наши преимущества:

- Поставка оригинальных импортных электронных компонентов напрямую с производств Америки, Европы и Азии, а так же с крупнейших складов мира;
- Широкая линейка поставок активных и пассивных импортных электронных компонентов (более 30 млн. наименований);
- Поставка сложных, дефицитных, либо снятых с производства позиций;
- Оперативные сроки поставки под заказ (от 5 рабочих дней);
- Экспресс доставка в любую точку России;
- Помощь Конструкторского Отдела и консультации квалифицированных инженеров;
- Техническая поддержка проекта, помощь в подборе аналогов, поставка прототипов;
- Поставка электронных компонентов под контролем ВП;
- Система менеджмента качества сертифицирована по Международному стандарту ISO 9001;
- При необходимости вся продукция военного и аэрокосмического назначения проходит испытания и сертификацию в лаборатории (по согласованию с заказчиком);
- Поставка специализированных компонентов военного и аэрокосмического уровня качества (Xilinx, Altera, Analog Devices, Intersil, Interpoint, Microsemi, Actel, Aeroflex, Peregrine, VPT, Syfer, Eurofarad, Texas Instruments, MS Kennedy, Miteq, Cobham, E2V, MA-COM, Hittite, Mini-Circuits, General Dynamics и др.);

Компания «Океан Электроники» является официальным дистрибьютором и эксклюзивным представителем в России одного из крупнейших производителей разъемов военного и аэрокосмического назначения «JONHON», а так же официальным дистрибьютором и эксклюзивным представителем в России производителя высокотехнологичных и надежных решений для передачи СВЧ сигналов «FORSTAR».



JONHON

«JONHON» (основан в 1970 г.)

Разъемы специального, военного и аэрокосмического назначения:

(Применяются в военной, авиационной, аэрокосмической, морской, железнодорожной, горно- и нефтедобывающей отраслях промышленности)

«FORSTAR» (основан в 1998 г.)

ВЧ соединители, коаксиальные кабели, кабельные сборки и микроволновые компоненты:

(Применяются в телекоммуникациях гражданского и специального назначения, в средствах связи, РЛС, а так же военной, авиационной и аэрокосмической отраслях промышленности).



Телефон: 8 (812) 309-75-97 (многоканальный)

Факс: 8 (812) 320-03-32

Электронная почта: ocean@oceanchips.ru

Web: <http://oceanchips.ru/>

Адрес: 198099, г. Санкт-Петербург, ул. Калинина, д. 2, корп. 4, лит. А