

Type MLS 125 °C Stainless Flatpack, Ultra-Long Life, Aluminum

Type MLS 125 °C

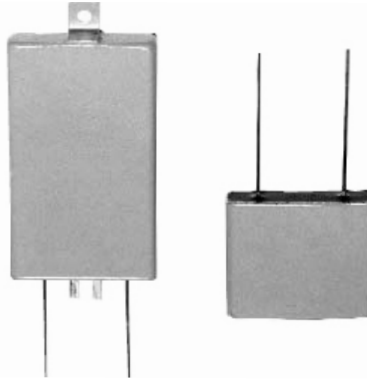

The Type MLS extends the super performance of the MLP from a maximum operating temperature of 85 °C to 125 °C. While the MLP is inherently capable of operation at 125 °C, its flat aluminum case can't withstand the higher temperature without inflating from internal pressure. The MLS incorporates a rugged, stainless steel case which assures flatness to beyond 125 °C. The MLS is perfect for hi-rel military systems and applications operating above 85 °C.

Highlights

- Near-hermetic welded seal
- Stainless-steel case
- 100 years expected operating life
- New 2 inch case size

Specifications

Operating Temperature:

–55 °C to +125 °C

Rated Voltage:

5.0 to 250 Vdc

Capacitance:

220 to 47,000 µF ±20%

Load Life:

2,000 h @ +125 °C

Leakage Current:

0.002 CV µA @ 25 °C and 5 min

Cold Impedance:

–55 °C multiple of 25 °C Z is ≤ 10 for up to 20 V, 2 for 25 V to 250 V

Ripple Current Multipliers:

Case Temperature

45 °C	55 °C	65 °C	75 °C	85 °C	95 °C	105 °C	115 °C	125 °C
1.41	1.32	1.22	1.12	1.00	0.87	0.71	0.50	0.00

Ambient Temperature, No Heatsink

45 °C	55 °C	65 °C	75 °C	85 °C	95 °C	105 °C	115 °C	125 °C
0.63	0.58	0.54	0.49	0.44	0.38	0.31	0.22	0.00

Frequency

	50 Hz	60 Hz	120 Hz	360 Hz	1 kHz	5 kHz	10 kHz & up
5 to 40 V	0.95	0.96	1.00	1.03	1.04	1.04	1.04
60 to 250 V	0.80	0.84	1.00	1.18	1.25	1.30	1.30

EIA Ripple Life:

10,000 h full load at 85 C per EIA IS-749

Δ capacitance ±10%

ESR 200% of limit

DCL 100% of limit

Shelf Life:
Thermal Resistance:

500 h at 125 °C, capacitance, ESR & DCL, initial requirements

Large Sides Heatsinked	Case Length	1.5"	2.0"	3.0"
	Insulation	°C/W	°C/W	°C/W
one	None	3.3	2.6	1.3
	Polyester	4.5	3.6	1.8
both	None	2.8	2.2	1.1
	Polyester	4	3.2	1.6

Vibration:

10 Hz to 2 kHz 0.06" pp max and 10 g, MIL-STD-202, Meth. 204

ESL:

< 30 nH measured 1/4" from case at 1 MHz

Weight:

Case EK 43 g typical

Case EA 76 g typical

Case EB 92 g typical

Terminals:

18 AWG copper wire with 60/40 tin-lead electroplate



RoHS-5 Compliant

Has more than 1000 ppm lead in some homogenous material but otherwise complies with the EU Directive 2002/95/EC requirement restricting the use of Lead (Pb), Mercury (Hg), Cadmium (Cd), Hexavalent chromium (Cr(VI)), PolyBrominated Biphenyls (PBB) and PolyBrominated Diphenyl Ethers (PBDE).

Type MLS 125 °C Stainless Flatpack, Ultra-Long Life, Aluminum

Specifications

Ripple Current Capability is set by the maximum permissible internal core temperature, 125 °C.

Air Cooled. The ripple currents in the ratings tables are for 85 °C case temperatures. For air temperatures without a heatsink use the Ambient Temperature, No Heatsink multipliers.

Heatsink Cooled. Temperature rise from the internal hottest spot, the core, to ambient air is:

$$\Delta T = I^2(ESR)(\Theta_{cc} + \Theta_{ca})$$

where Θ_{cc} is the thermal resistance from core to case and Θ_{ca} from case to ambient. To calculate maximum ripple capability with the MLP attached to a heatsink use the maximum core temperature and the values for Θ_{cc} .

As an illustration, suppose you operate an MLS332M060EB1C in 65 °C air and attach it to a commercial heatsink with a free-air thermal resistance of 2.7 °C/W. Use a good thermal grease between the MLS and the heatsink, and the total thermal resistance is 2.7 + 1.8 or 4.5 °C/W. The power which would heat the core to 125 °C is (125-65)/4.5 or 13.3 W. For an ESR of 31 mΩ, 13.3 W equates to a ripple current of 20.7A, however, the wire leads are rated for only 20 A.

Outline Drawings

Style A: Mounting Tabs

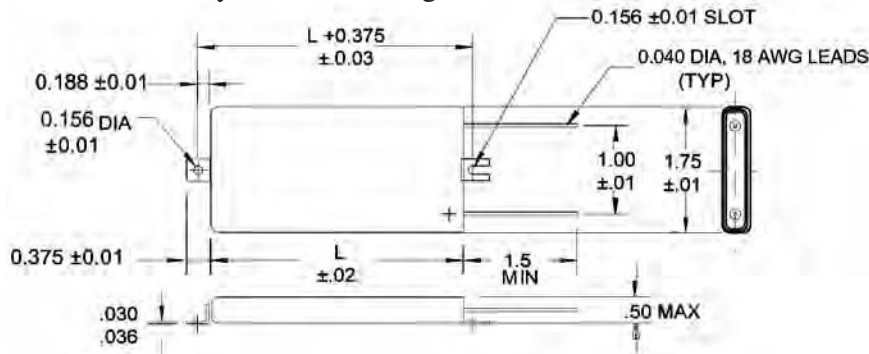

Case Code	Length L (in)	Weight (g)
EK	1.5	43
EA	2.0	76
EB	3.0	92

Style C: Two Leads, No Tabs

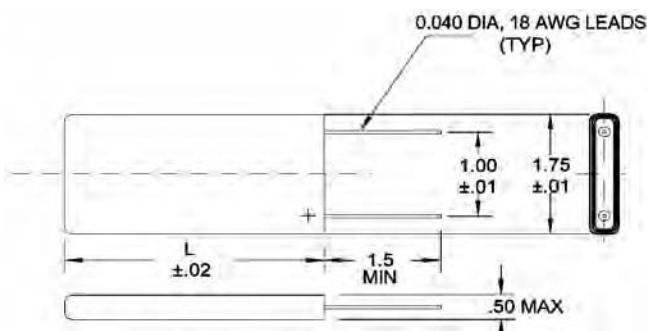

Style D: Hook Leads

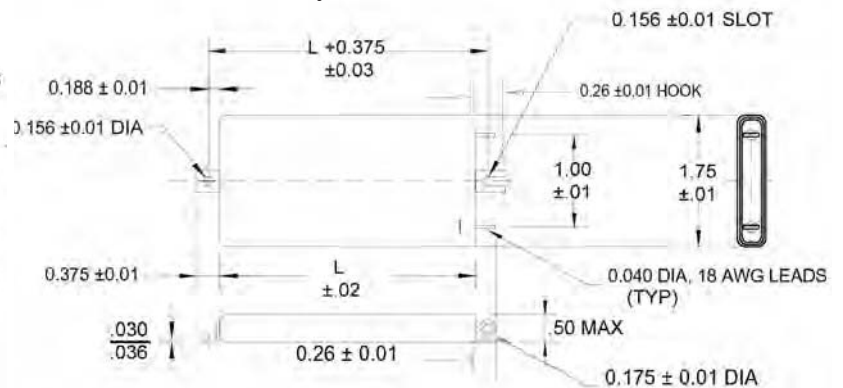

Note: The mounting tabs are at case potential and the negative lead connects to the case through the electrolyte.

Part Numbering System

MLS	821	M	200	EB	0	A
↓	↓	↓	↓	↓	↓	↓
Type	Capacitance	Tolerance	Rated Voltage	Case Code	Insulation	Mounting Style
MLS	821=820 μF 102 = 1000 μF	M=±20%	Vdc	EK, L=1.5 in. EA, L=2.0 in. EB, L=3.0 in.	0 = bare can 1 = polyester	A = mounting tabs C = two leads/no tabs D = hook leads/tabs

Type MLS 125 °C Stainless Flatpack, Ultra-Long Life, Aluminum

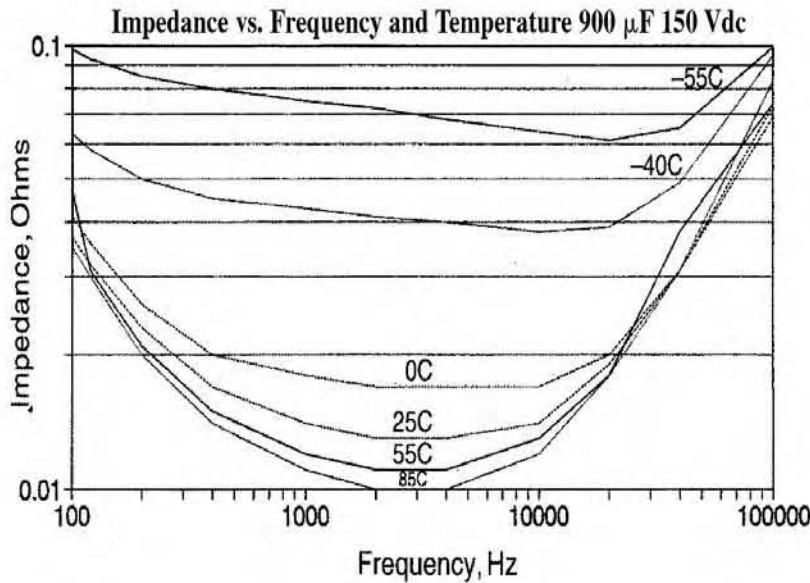
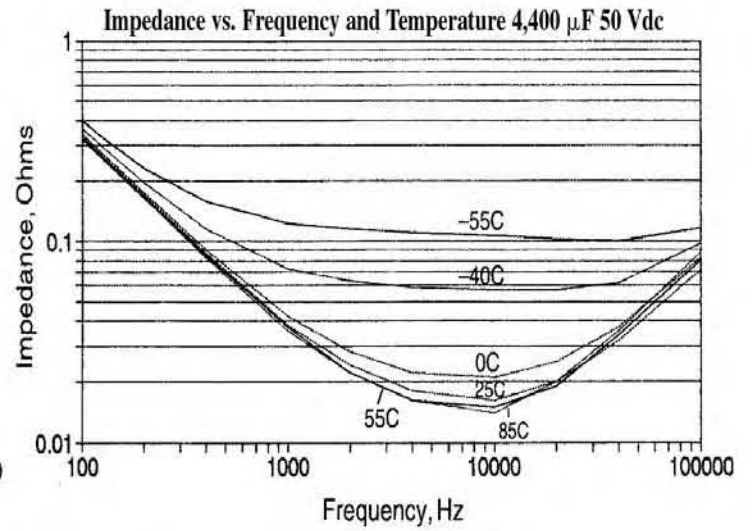
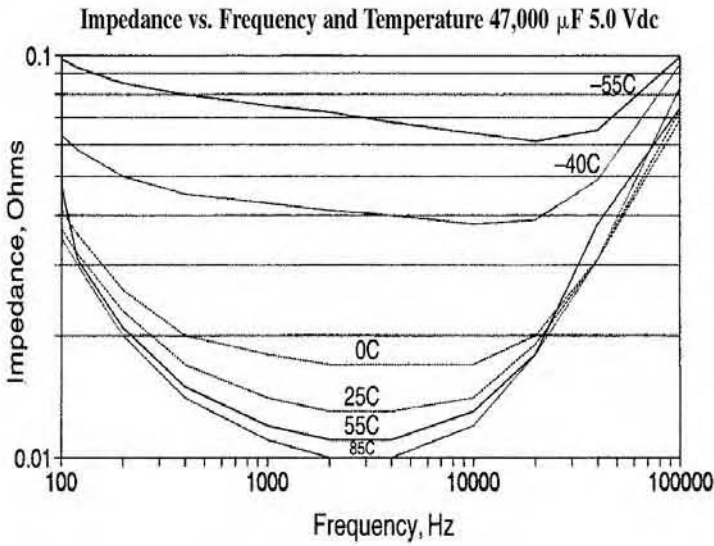

MLS102M150EB0D Life Test at 125 °C, 150 V

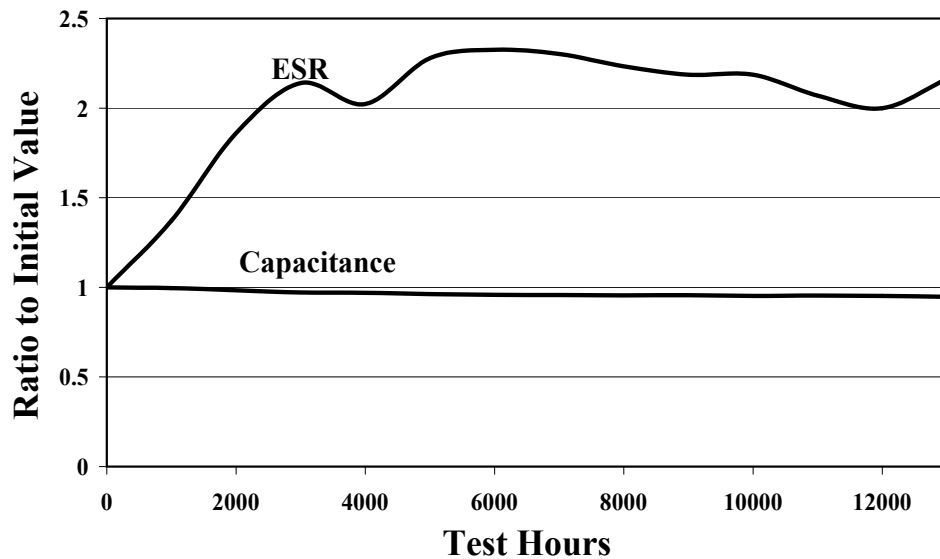

Type MLS 125 °C Stainless Flatpack, Ultra-Long Life, Aluminum

Typical Performance Curves

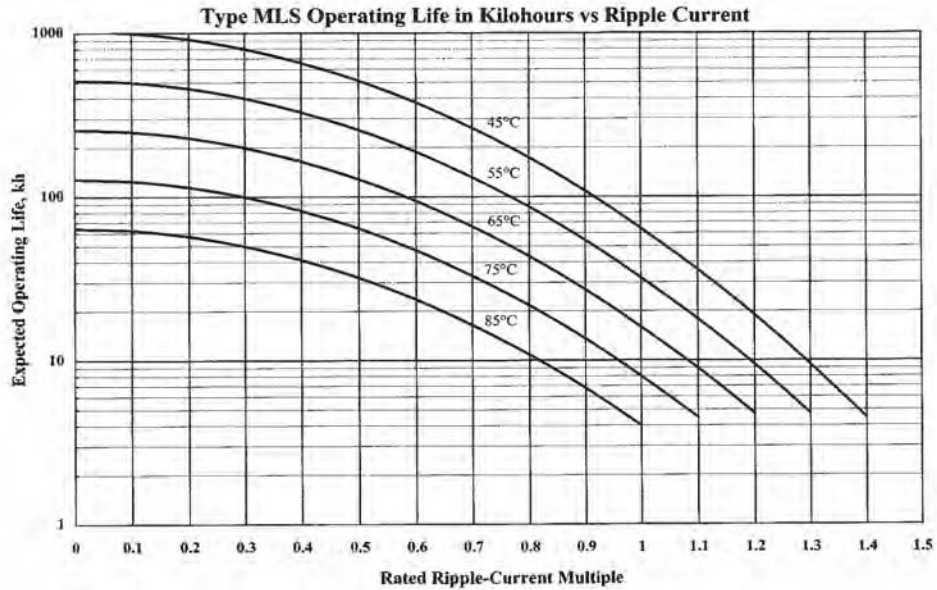

Ratings

Cap (µF)	Catalog Part Number	ESR max 25 °C (mΩ)		Ripple (A) Case @ 85°C		Length (inches)
		120 Hz	20 kHz	120 Hz	20 kHz	
5 Vdc (7.5 Vdc Surge) [105 °C: 7.5 Vdc (10 Vdc Surge)]						
19,000	MLS193M5R0EK0C	76	66	12.6	13.6	1.5
28,000	MLS283M5R0EA0C	50	44	19.9	21.4	2.0
47,000	MLS473M5R0EB0C	30	26	32.0	34.4	3.0
7.5 Vdc (10 Vdc Surge) [105 °C: 10 Vdc (13 Vdc Surge)]						
17,000	MLS173M7R5EK0C	77	67	12.5	13.5	1.5
26,000	MLS263M7R5EA0C	51	45	19.8	21.1	2.0
43,000	MLS433M7R5EB0C	31	27	31.5	33.8	3.0
10 Vdc (15 Vdc Surge) [105 °C: 16 Vdc (20 Vdc Surge)]						
13,000	MLS133M010EK0C	81	69	12.2	13.3	1.5
23,000	MLS233M010EA0C	51	45	19.8	21.1	2.0
38,000	MLS383M010EB0C	31	27	31.5	33.8	3.0
20 Vdc (30 Vdc Surge) [105 °C: 30 Vdc (40 Vdc Surge)]						
6,800	MLS682M020EK0C	84	69	11.0	12.2	1.5
10,000	MLS103M020EA0C	56	46	13.6	15.0	2.0
17,000	MLS173M020EB0C	33	27	17.6	19.5	3.0
40 Vdc (50 Vdc Surge) [105 °C: 50 Vdc (63 Vdc Surge)]						
4,400	MLS442M040EK0C	97	70	10.3	12.1	1.5
6,600	MLS662M040EA0C	62	46	12.9	15.0	2.0
11,000	MLS113M040EB0C	36	27	16.9	19.5	3.0
60 Vdc (75 Vdc Surge) [105 °C: 80 Vdc (100 Vdc Surge)]						
1,500	MLS152M060EK0C	106	77	9.8	11.5	1.5

Cap (µF)	Catalog Part Number	ESR max 25 °C (mΩ)		Ripple (A) Case @ 85°C		Length (inches)
		120 Hz	20 kHz	120 Hz	20 kHz	
2,100	MLS212M060EA0C	72	52	11.9	14.1	2.0
3,300	MLS332M060EB0C	44	31	15.3	18.2	3.0
75 Vdc (100 Vdc Surge) [105 °C: 100 Vdc (125 Vdc Surge)]						
1,100	MLS112M075EK0C	112	78	9.6	11.5	1.5
1,600	MLS162M075EA0C	76	54	11.6	13.8	2.0
2,700	MLS272M075EB0C	46	33	14.9	17.6	3.0
100 Vdc (125 Vdc Surge) [105 °C: 150 Vdc (180 Vdc Surge)]						
500	MLS501M100EK0C	355	248	5.4	6.4	1.5
770	MLS771M100EA0C	238	166	6.6	7.8	2.0
1,300	MLS132M100EB0C	143	100	8.5	10.1	3.0
150 Vdc (175 Vdc Surge) [105 °C: 200 Vdc (250 Vdc Surge)]						
400	MLS401M150EK0C	388	253	5.1	6.4	1.5
600	MLS601M150EA0C	261	168	6.3	7.8	2.0
1,000	MLS102M150EB0C	158	100	8.1	10.1	3.0
200 Vdc (225 Vdc Surge) [105 °C: 250 Vdc (300 Vdc Surge)]						
330	MLS331M200EK0C	426	258	4.9	6.2	1.5
490	MLS491M200EA0C	285	172	6.0	7.7	2.0
820	MLS821M200EB0C	172	103	7.7	10.0	3.0
250 Vdc (275 Vdc Surge) [105 °C: 250 Vdc (300 Vdc Surge)]						
220	MLS221M250EK0C	597	393	4.1	5.1	1.5
330	MLS331M250EA0C	399	262	5.0	6.3	2.0
560	MLS561M250EB0C	240	157	6.5	8.1	3.0

Компания «Океан Электроники» предлагает заключение долгосрочных отношений при поставках импортных электронных компонентов на взаимовыгодных условиях!

Наши преимущества:

- Поставка оригинальных импортных электронных компонентов напрямую с производств Америки, Европы и Азии, а так же с крупнейших складов мира;
- Широкая линейка поставок активных и пассивных импортных электронных компонентов (более 30 млн. наименований);
- Поставка сложных, дефицитных, либо снятых с производства позиций;
- Оперативные сроки поставки под заказ (от 5 рабочих дней);
- Экспресс доставка в любую точку России;
- Помощь Конструкторского Отдела и консультации квалифицированных инженеров;
- Техническая поддержка проекта, помощь в подборе аналогов, поставка прототипов;
- Поставка электронных компонентов под контролем ВП;
- Система менеджмента качества сертифицирована по Международному стандарту ISO 9001;
- При необходимости вся продукция военного и аэрокосмического назначения проходит испытания и сертификацию в лаборатории (по согласованию с заказчиком);
- Поставка специализированных компонентов военного и аэрокосмического уровня качества (Xilinx, Altera, Analog Devices, Intersil, Interpoint, Microsemi, Actel, Aeroflex, Peregrine, VPT, Syfer, Eurofarad, Texas Instruments, MS Kennedy, Miteq, Cobham, E2V, MA-COM, Hittite, Mini-Circuits, General Dynamics и др.);

Компания «Океан Электроники» является официальным дистрибьютором и эксклюзивным представителем в России одного из крупнейших производителей разъемов военного и аэрокосмического назначения «JONHON», а так же официальным дистрибьютором и эксклюзивным представителем в России производителя высокотехнологичных и надежных решений для передачи СВЧ сигналов «FORSTAR».



JONHON

«JONHON» (основан в 1970 г.)

Разъемы специального, военного и аэрокосмического назначения:

(Применяются в военной, авиационной, аэрокосмической, морской, железнодорожной, горно- и нефтедобывающей отраслях промышленности)

«FORSTAR» (основан в 1998 г.)

ВЧ соединители, коаксиальные кабели, кабельные сборки и микроволновые компоненты:

(Применяются в телекоммуникациях гражданского и специального назначения, в средствах связи, РЛС, а так же военной, авиационной и аэрокосмической отраслях промышленности).



Телефон: 8 (812) 309-75-97 (многоканальный)

Факс: 8 (812) 320-03-32

Электронная почта: ocean@oceanchips.ru

Web: <http://oceanchips.ru/>

Адрес: 198099, г. Санкт-Петербург, ул. Калинина, д. 2, корп. 4, лит. А