



# Cree Performance XHP35 LED Module

Power of Cree XHP Series in Standard and Custom LED modules

# Data Sheet

## Illumination Accelerated

**Design Faster** – use standard, UL-listed modules

**Superior Performance & Cost** – top flux bin LEDs at competitive prices

**Thermal Interface Included** – pre-installed to simplify assembly

**Add Standard Optics** – configured for off-the-shelf optics

## Primary Applications



High Mast	Canopy
Streetlight	Garage
Stadium	Portable
Architectural	High bay



## Superior Performance in Standard & Custom Modules

- Market leading L90 & L70 lifetimes, even in high stress conditions
- 70, 80, and 90 CRI LEDs available
- Metal core PCB for optimal thermal management
- Configurable with off the shelf optics, and heat sinks
- Private label or custom designs available

## Simplify Your Next Design

The Cree performance modules, built with Cree SC5 technology, are an off-the-shelf platform to rapidly move from prototype to finished LED lighting fixture. These versatile building blocks are UL-listed and include Cree XHP35, XHP50 & XHP70 LEDs in square, linear or rectangle formats. The thermal interface is already installed with easy to use connectors to help simplify the lighting design and get to market faster. These competitively priced modules come in a range of lumen outputs and can achieve both DLC Premium or DLC Standard lumens per watt specifications.

## Integrate Further

Opulent Americas also offers standard heat sinks and fully assembled IP-rated modules.

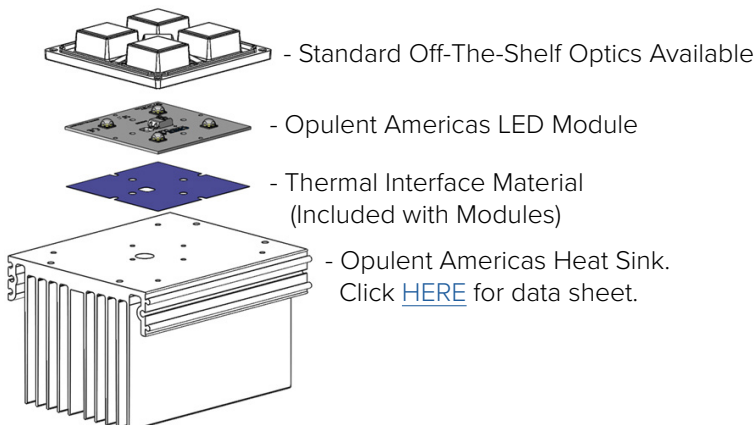

## About Opulent Americas

Opulent Americas, part of Singapore based Opulent Group, is a fully integrated, global manufacturer for the lighting, automotive and medical industries. Through 30 years of manufacturing experience and state-of-the-art facilities, the company offers leading solid state lighting components and modules. The NC-based office provides quick engineering & sales support with an R&D lab to provide prototype development and custom solutions. See [Opulent-Americas.com](http://Opulent-Americas.com) for more information.



# XHP35 Series Specifications

## Product Selection Table

Configuration	LED Layout	Part Number	CCT	CRI	Binning	Luminous Flux (lm)		Efficacy Nominal (lm/W)	Watts (W)	
						Nominal	Max		Nominal	Max
Rectangular <sup>(1)</sup>	2x2	XHP35A-0R-04-0D0HC427E	2700K	80	5-Step	1900	4537	120	16	51
Rectangular <sup>(1)</sup>	2x2	XHP35A-0R-04-0D0BD430E	3000K	70	5-Step	2200	5253	139	16	51
Rectangular <sup>(1)</sup>	2x2	XHP35A-0R-04-0D0BE240E	4000K	70	5-Step	2360	5635	149	16	51
Rectangular <sup>(1)</sup>	2x2	XHP35A-0R-04-0D0BE450E	5000K	70	5-Step	2540	6065	161	16	51
Rectangular <sup>(1)</sup>	2x2	XHP35A-0R-04-0D0BE457E	5700K	70	5-Step	2540	6065	161	16	51
Rectangular <sup>(2)</sup>	2x4	XHP35A-0R-08-0D0HC427E	2700K	80	5-Step	3800	9074	120	32	100 <sup>(4)</sup>
Rectangular <sup>(2)</sup>	2x4	XHP35A-0R-08-0D0BD430E	3000K	70	5-Step	4400	10506	139	32	100 <sup>(4)</sup>
Rectangular <sup>(2)</sup>	2x4	XHP35A-0R-08-0D0BE240E	4000K	70	5-Step	4720	11270	149	32	100 <sup>(4)</sup>
Rectangular <sup>(2)</sup>	2x4	XHP35A-0R-08-0D0BE450E	5000K	70	5-Step	5080	12131	161	32	100 <sup>(4)</sup>
Rectangular <sup>(2)</sup>	2x4	XHP35A-0R-08-0D0BE457E	5700K	70	5-Step	5080	12131	161	32	100 <sup>(4)</sup>
Rectangular <sup>(3)</sup>	2x6	XHP35A-0R-12-0D0HC427E	2700K	80	5-Step	5700	13610	120	48	100/150 <sup>(4)</sup>
Rectangular <sup>(3)</sup>	2x6	XHP35A-0R-12-0D0BD430E	3000K	70	5-Step	6600	15759	139	48	100/150 <sup>(4)</sup>
Rectangular <sup>(3)</sup>	2x6	XHP35A-0R-12-0D0BE240E	4000K	70	5-Step	7080	16906	149	48	100/150 <sup>(4)</sup>
Rectangular <sup>(3)</sup>	2x6	XHP35A-0R-12-0D0BE450E	5000K	70	5-Step	7620	18197	161	48	100/150 <sup>(4)</sup>
Rectangular <sup>(3)</sup>	2x6	XHP35A-0R-12-0D0BE457E	5700K	70	5-Step	7620	18197	161	48	100/150 <sup>(4)</sup>

<sup>(1)</sup> Product performance at 350mA T<sub>j</sub> = 85°C.

<sup>(2)</sup> Product performance at 700mA T<sub>j</sub> = 85°C.

<sup>(3)</sup> Product performance at 1050mA T<sub>j</sub> = 85°C.

<sup>(4)</sup> Input power not to exceed 100W for UL Class 2. Suitability for usage in other than Class 2 circuits shall be determined in the end-product investigation.

<sup>(5)</sup> Cree XLamp XHP35 LED order codes specify only a minimum flux bin and not a maximum. Opulent North America may ship modules in flux bins higher than the minimum specified by the order code without advance notice. Shipments will always adhere to the chromaticity bin restrictions specified by the order code.



# XHP35 Series Specifications

## Order Code Formatting

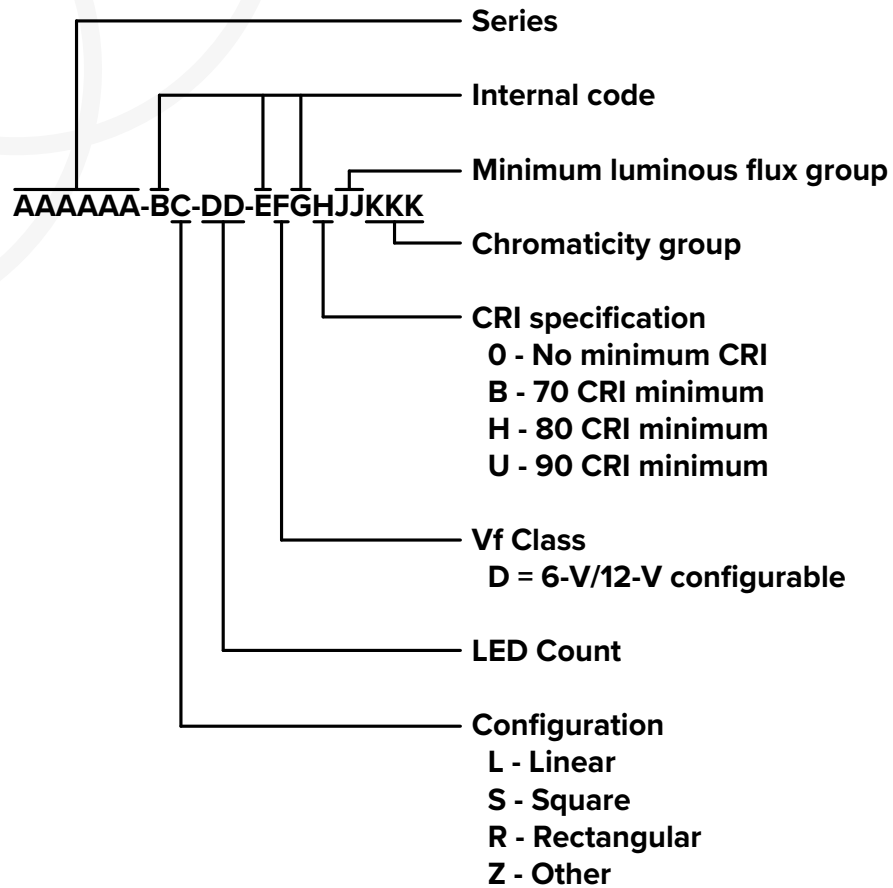

# XHP35 Series Specifications

## Electrical Characteristics

Part Number	Forward Voltage (v)		Typical Thermal Resistance - Junction to Heat Sink (K/W) RTh J-HS
	Typical	Maximum	
XHP35A-0R-04-x	45.2	47.6	1.8
XHP35A-0R-08-x	45.2	47.6	1.8
XHP35A-0R-12-x	45.2	47.6	1.8

Intended for connection to a class 2 power source with a maximum operating voltage of 50 Vdc

## Maximum Ratings

Part Number	DC Current (A)	Tsp Temp (°C)	Power (W)
XHP35A-0R-04-x	1.05	105	51
XHP35A-0R-08-x	2.10	105	100 <sup>(1)</sup>
XHP35A-0R-12-x	3.15	105	100/150 <sup>(1)</sup>

<sup>(1)</sup> Input power not to exceed 100W for UL Class 2. Suitability for usage in other than Class 2 circuits shall be determined in the end-product investigation.

## Relative Flux Vs Board Current (TJ = 85°C)

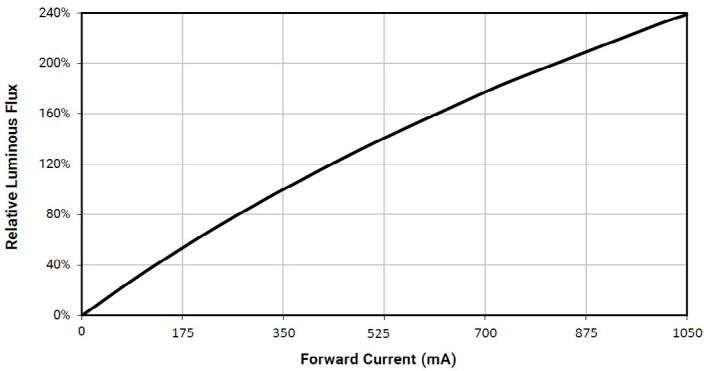

(XHP35A-0R-04-x)

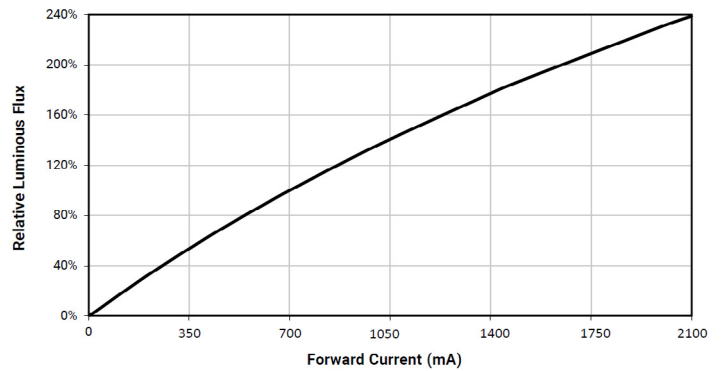

(XHP35A-0R-08-x)

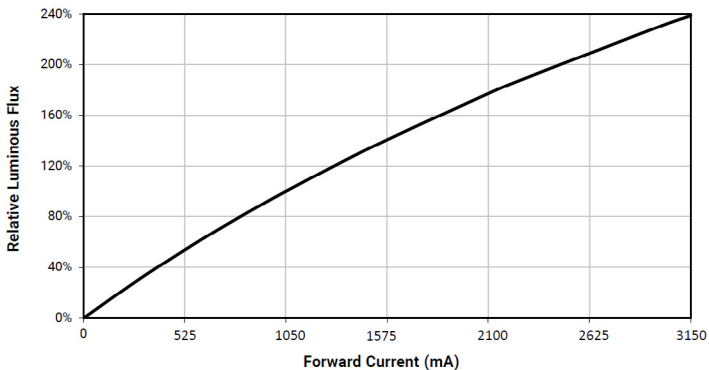

(XHP35A-0R-12-x)

# XHP35 Series Specifications

## Spatial Distribution

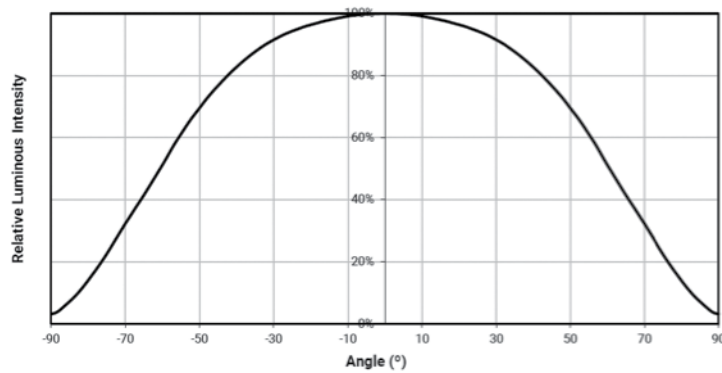

## Performance Groups – Chromaticity

5-Step Binning					
CCT	Center Point		Major Axis	Minor Axis	Rotation Angle (°)
	X	Y	a	b	
5700K	0.3287	0.3417	0.01230	0.00600	72.0
5000K	0.3447	0.3553	0.01400	0.00520	65.0
4000K	0.3818	0.3797	0.001420	0.00550	61.5
3000K	0.4338	0.4030	0.01390	0.00680	53.2
2700K	0.4577	0.4099	0.01350	0.00700	48.5

## Standard White Chromaticity Regions Plotted On The CIE 1931 Curve

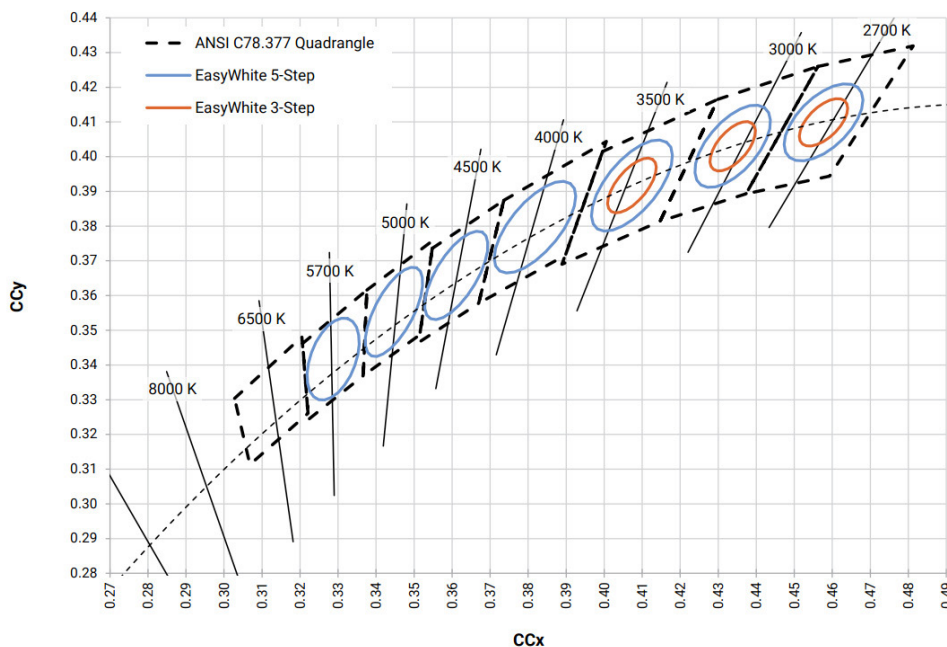

# XHP35 Series Specifications

## Thermal Interface Properties

Property	Test Method	Value	Unit
Color	-	Blue	-
Thickness	ASTM D374	0.3	mm
Construction	-	Silicone / Ceramic	-
Temperature Range	EN344	-50-200	°C
Breakdown Voltage	ASTM D149	>8.0	Kv/mm
Flame Rating	UL94	V-0	-
Thermal Conductivity	ASTM D5470	3.0	W/m-K

Intended for connection to a class 2 power source with a maximum operating voltage of 50 Vdc

Note: Release liner must be removed for proper thermal performance. Do not remove thermal Interface Material.

## Board Material Properties

Property	Value	Unit
Solder Mask Color	White	-
Thickness	.062	in
Construction	AL	-
Temperature	130	°C
Flame Rating	V-0	-
Copper Thickness	2	oz

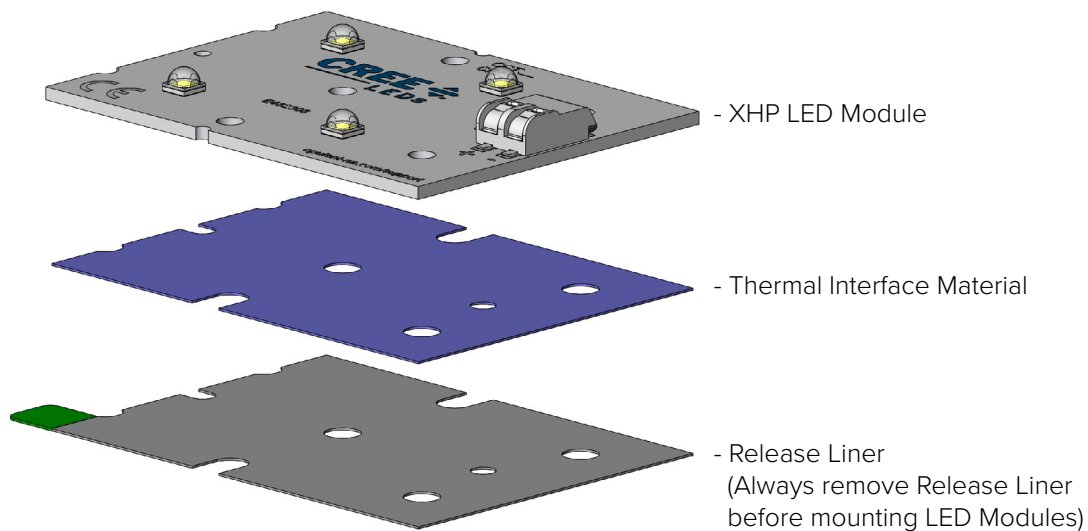

# XHP35 Series Specifications

## Opulent Americas Rectangular 4 LED XHP35 Module

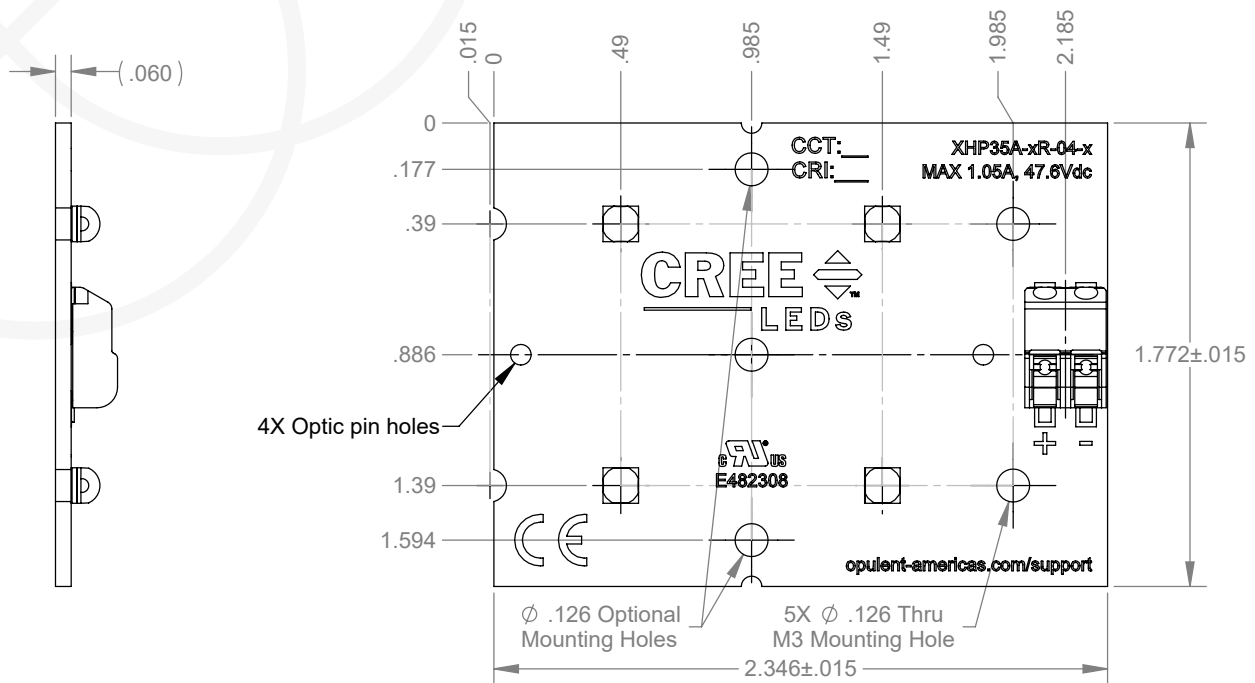

### Schematic

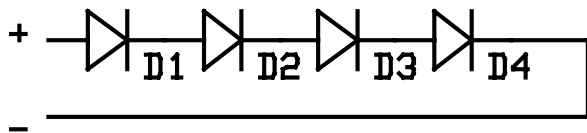

1. Dual Poke-In Connectors accept 18-24 AWG solid or stranded wire
2. Recommended Mounting Hardware: 4x M3-5 Socket Head Cap Screws

# XHP35 Series Specifications

## Opulent Americas Rectangular 8 LED XHP35 Module

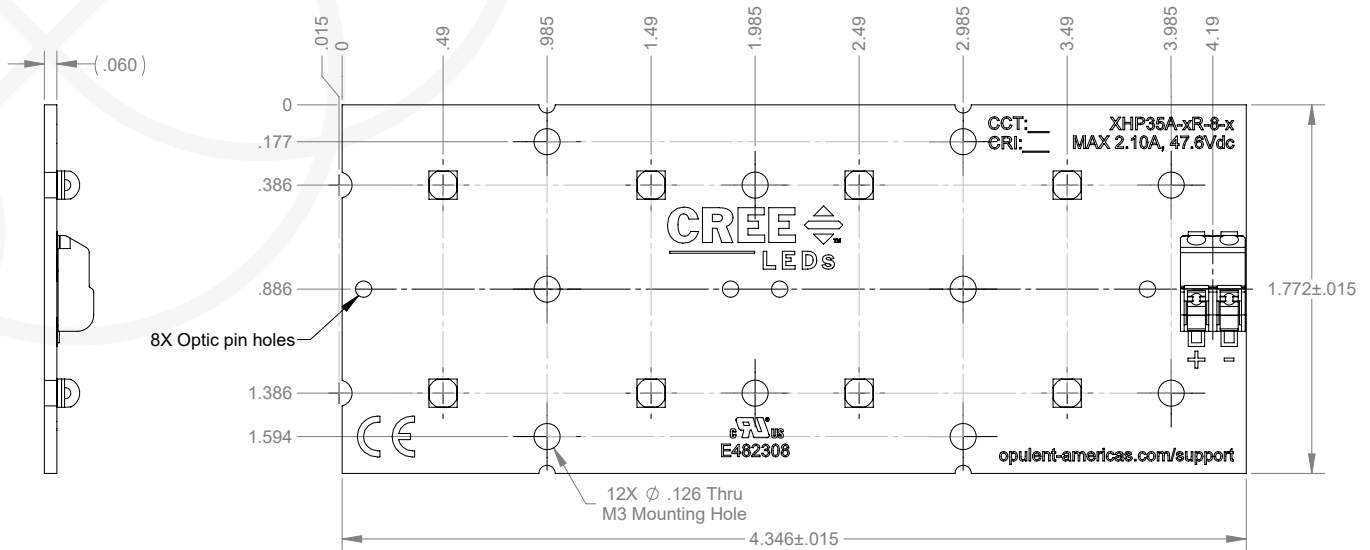

### Schematic

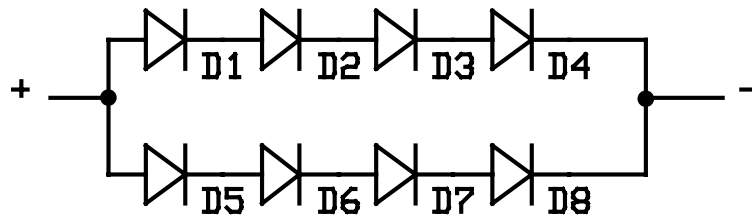

1. Dual Poke-In Connectors accept 18-24 AWG solid or stranded wire
2. Recommended Mounting Hardware: 6x M3-5 Socket Head Cap Screws



# XHP35 Series Specifications

## Opulent Americas Rectangular 12 LED XHP35 Module

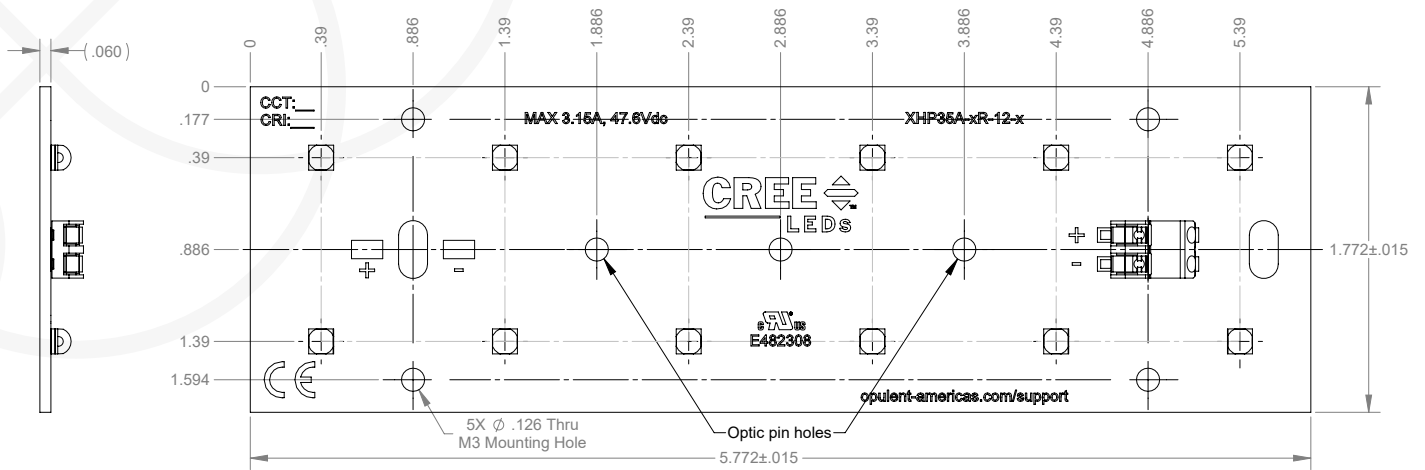

### Schematic

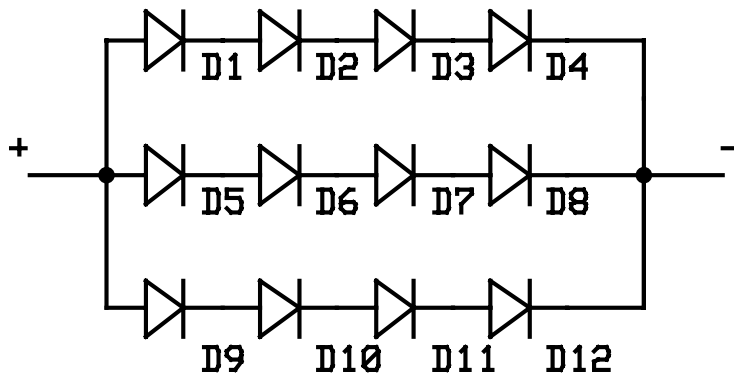

1. Dual Poke-In Connectors accept 18-24 AWG solid or stranded wire
2. Recommended Mounting Hardware: 5x M3-5 Socket Head Cap Screws

Компания «Океан Электроники» предлагает заключение долгосрочных отношений при поставках импортных электронных компонентов на взаимовыгодных условиях!

Наши преимущества:

- Поставка оригинальных импортных электронных компонентов напрямую с производств Америки, Европы и Азии, а так же с крупнейших складов мира;
- Широкая линейка поставок активных и пассивных импортных электронных компонентов (более 30 млн. наименований);
- Поставка сложных, дефицитных, либо снятых с производства позиций;
- Оперативные сроки поставки под заказ (от 5 рабочих дней);
- Экспресс доставка в любую точку России;
- Помощь Конструкторского Отдела и консультации квалифицированных инженеров;
- Техническая поддержка проекта, помощь в подборе аналогов, поставка прототипов;
- Поставка электронных компонентов под контролем ВП;
- Система менеджмента качества сертифицирована по Международному стандарту ISO 9001;
- При необходимости вся продукция военного и аэрокосмического назначения проходит испытания и сертификацию в лаборатории (по согласованию с заказчиком);
- Поставка специализированных компонентов военного и аэрокосмического уровня качества (Xilinx, Altera, Analog Devices, Intersil, Interpoint, Microsemi, Actel, Aeroflex, Peregrine, VPT, Syfer, Eurofarad, Texas Instruments, MS Kennedy, Miteq, Cobham, E2V, MA-COM, Hittite, Mini-Circuits, General Dynamics и др.);

Компания «Океан Электроники» является официальным дистрибьютором и эксклюзивным представителем в России одного из крупнейших производителей разъемов военного и аэрокосмического назначения «**JONHON**», а так же официальным дистрибьютором и эксклюзивным представителем в России производителя высокотехнологичных и надежных решений для передачи СВЧ сигналов «**FORSTAR**».



## JONHON

«**JONHON**» (основан в 1970 г.)

Разъемы специального, военного и аэрокосмического назначения:

(Применяются в военной, авиационной, аэрокосмической, морской, железнодорожной, горно- и нефтедобывающей отраслях промышленности)

«**FORSTAR**» (основан в 1998 г.)

ВЧ соединители, коаксиальные кабели, кабельные сборки и микроволновые компоненты:

(Применяются в телекоммуникациях гражданского и специального назначения, в средствах связи, РЛС, а так же военной, авиационной и аэрокосмической отраслях промышленности).



Телефон: 8 (812) 309-75-97 (многоканальный)

Факс: 8 (812) 320-03-32

Электронная почта: [ocean@oceanchips.ru](mailto:ocean@oceanchips.ru)

Web: <http://oceanchips.ru/>

Адрес: 198099, г. Санкт-Петербург, ул. Калинина, д. 2, корп. 4, лит. А